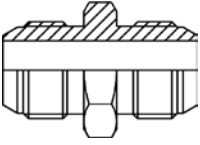
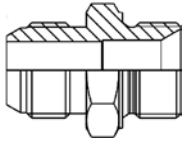
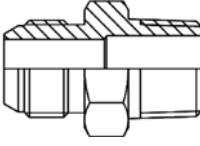

HIGH PRESSURE - adapters

JIS adapters (TOYOTA)

BSP 60° male thread	
	
A401	
code (carbon steel)	thread size [inch]
TI-A401-04-04	1/4
TI-A401-06-06	3/8
TI-A401-08-08	1/2
TI-A401-12-12	3/4
TI-A401-16-16	1

BSP 60° male thread	
	
A402	
code (carbon steel)	thread size [inch]
TI-A402-04-04	1/4
TI-A402-06-06	3/8
TI-A402-08-08	1/2
TI-A402-12-12	3/4
TI-A402-16-16	1

BSP 60° male thread / BSPT	
	
A403	
code (carbon steel)	thread size [inch]
TI-A403-02-02	1/8
TI-A403-04-04	1/4
TI-A403-06-06	3/8
TI-A403-08-08	1/2
TI-A403-12-12	3/4
TI-A403-16-16	1
TI-A403-20-20	1.1/4
TI-A403-24-24	1.1/2

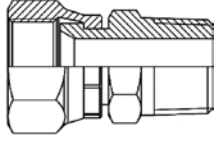
BSP 60° female / BSPT male thread	
	
A404	
code (carbon steel)	thread size [inch]
TI-A404-04-04	1/4
TI-A404-06-06	3/8
TI-A404-08-08	1/2
TI-A404-12-12	3/4
TI-A404-16-16	1

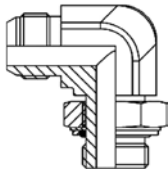
BSP 60° male thread / BSP	
	
A405	
code (carbon steel)	thread size [inch]
TI-A405-04-04	1/4
TI-A405-06-06	3/8
TI-A405-08-08	1/2
TI-A405-12-12	3/4
TI-A405-16-16	1

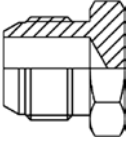
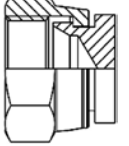
BSP 60° male thread		BSP 60° female thread
		
A406		A407
code (carbon steel)	code (carbon steel)	thread size [inch]
TI-A406-04-04	TI-A407-04-04	1/4
TI-A406-06-06	TI-A407-06-06	3/8
TI-A406-08-08	TI-A407-08-08	1/2
TI-A406-12-12	TI-A407-12-12	3/4
TI-A406-16-16	TI-A407-16-16	1

HIGH PRESSURE - adapters

JIS adapters (KOMATSU)

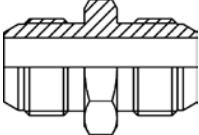

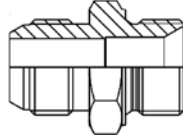
60° metric male thread		
		
A501		
code (carbon steel)	thread size [mm]	
TI-A501-14-14	M14x1.5	
TI-A501-16-16	M16x1.5	
TI-A501-18-18	M18x1.5	
TI-A501-22-22	M22x1.5	
TI-A501-24-24	M24x1.5	
TI-A501-30-30	M30x1.5	
TI-A501-33-33	M33x1.5	

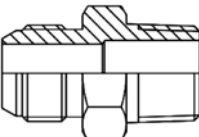
60° metric / BSPT male thread		
		
A502		
code (carbon steel)	thread size [mm]	thread size [inch]
TI-A502-14-04	M14x1.5	1/4
TI-A502-18-06	M18x1.5	3/8
TI-A502-22-08	M22x1.5	1/2
TI-A502-24-10	M24x1.5	5/8
TI-A502-30-12	M30x1.5	3/4
TI-A502-33-16	M33x1.5	1

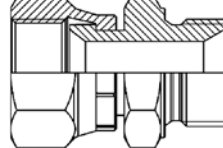
60° metric / BSPT male thread		
		
A503		
code (carbon steel)	thread size [mm]	thread size [inch]
TI-A503-14-04	M14x1.5	1/4
TI-A503-16-06	M16x1.5	3/8
TI-A503-18-06	M18x1.5	3/8
TI-A503-22-08	M22x1.5	1/2
TI-A503-24-10	M24x1.5	5/8
TI-A503-30-12	M30x1.5	3/4
TI-A503-33-16	M33x1.5	1

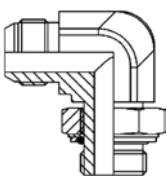
60° metric female / BSP 60° male thread		
		
A504		
code (carbon steel)	thread size [mm]	thread size [inch]
TI-A504-14-04	M14x1.5	1/4
TI-A504-18-06	M18x1.5	3/8
TI-A504-22-08	M22x1.5	1/2
TI-A504-30-12	M30x1.5	3/4

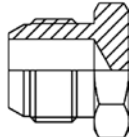
60° metric / BSP male thread		
		
A505		
code (carbon steel)	thread size [mm]	thread size [inch]
TI-A505-14-04	M14x1.5	1/4
TI-A505-16-06	M16x1.5	3/8
TI-A505-18-06	M18x1.5	3/8
TI-A505-22-08	M22x1.5	1/2
TI-A505-30-12	M30x1.5	3/4
TI-A505-33-16	M33x1.5	1

60° metric male thread		60° metric female thread
		
A506		A507
code (carbon steel)	code (carbon steel)	thread size [mm]
TI-A506-14-14	TI-A507-14-14	M14x1.5
TI-A506-16-16	TI-A507-16-16	M16x1.5
TI-A506-18-18	TI-A507-18-18	M18x1.5
TI-A506-22-22	TI-A507-22-22	M22x1.5
TI-A506-24-24	TI-A507-24-24	M24x1.5
TI-A506-30-30	TI-A507-30-30	M30x1.5
TI-A506-33-33	TI-A507-33-33	M33x1.5