

INDUSTRIAL FITTINGS - couplings

Emergency couplings - SBC



- Material:** Aluminium, brass, AISI 316
- Seals:** Viton - O-ring
PTFE - flat seal of the connection side (other also available)
- Connections:** As a standard: BSP or NPT thread, PN EN1092-1, ANSI B16.5 or TTMA flanges (other also available)
- Working press.:** 25 bar (optionally 40 bar)
- Working temp.:** From -25°C up to +80°C (the acceptable working temperature ranges from -54°C up to +250°C for proper coupling material and seals, after written confirmation for application with a particular medium from the manufacturer).

Operation

A coupling designed to transmit a load of a strained hose to breaking bolts. The bolts are broken before the hose and its fittings collapse. The coupling disconnects. Simultaneously spring valves in both coupling halves lock, so the transferred medium is not released to the atmosphere. The coupling contains three breaking pins. After emergency situation which caused disconnection of the coupling and breaking of bolts, the coupling can be easily connected using a new set of bolts. However before it is reused, the coupling always requires thorough inspection. The breaking load can be set at a lower level, accordingly, the maximum working pressure is lower as well. The seal made of EPDM, NBR, Chemraz or Kalrez is also available.

Application

Emergency couplings are used in industrial installations and reloading systems, to handle chemicals, fuels and gases.



Standards

The couplings meet the requirements of ATEX, ADR, RID, IMDG, Pressure Equipment Directive 97/23/EC (PED).

INDUSTRIAL SBC	MARINE SBC
<p>The couplings disconnect at an angle ranging from 0° to 90°. The coupling is assembled on the installation at one end, and hose assembly at the other.</p>	<p>The coupling is disconnected by a straight (0°) pull only. Any bending of the coupling is not transmitted to the breaking bolts. The coupling is assembled between two hose lengths.</p>

INDUSTRIAL FITTINGS - couplings

Emergency couplings - SBC

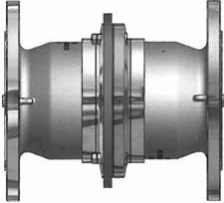
picture	code	connection	break. force [kN]	work. press. [bar]	material	seal		weight [kg]	
						O-ring	thread		
	MK-SBC-N103D1101B	1" BSP female	3.2	16	aluminium	FPM/ FKM	PUR	-	
	MK-SBC-N210D1101B	2" BSP female	9					0.90	
	MK-SBC-N312D1101B	2.1/2" BSP female	10					2.50	
	MK-SBC-N414D1101B	3" BSP female	15	10				2.90	
	MK-SBC-N516D1101B	4" BSP female	24					5.30	
	MK-SBC-N6110D1101B	6" BSP female	54					15.90	
	MK-SBC-N103D2201B	1" BSP female	3.2	16	brass			-	
	MK-SBC-N210D2201B	2" BSP female	9					-	
	MK-SBC-N312D2201B	2.1/2" BSP female	16					-	
	MK-SBC-N414D2201B	3" BSP female	24	25				AISI 316	-
	MK-SBC-N516D2201B	4" BSP female	38						-
	MK-SBC-N103D4401A	1" BSP female	4.8						1.70
	MK-SBC-N210D4401A	2" BSP female	13	2.60					
	MK-SBC-N312D4401A	2.1/2" BSP female	22	7.40					
	MK-SBC-N414D4401A	3" BSP female	33	8.50					
	MK-SBC-N516D4401A	4" BSP female	52	15.50					
	MK-SBC-N6110D4401A	6" BSP female	92	46.80					
		MK-SBC-N104D1101	1" NPT female	3.2	16			aluminium	FPM/ FKM
MK-SBC-N211D1101		2" NPT female	9	0.90					
MK-SBC-N313D1101		2.1/2" NPT female	10	2.50					
MK-SBC-N415D1101		3" NPT female	15	10	2.90				
MK-SBC-N517D1101		4" NPT female	24		5.30				
MK-SBC-NV124D1101		5" NPT female	37		12.00				
MK-SBC-N6111D1101		6" NPT female	54	15.90					
MK-SBC-N104D2201		1" NPT female	3.2	16	brass	-			
MK-SBC-N211D2201		2" NPT female	9			-			
MK-SBC-N313D2201		2.1/2" NPT female	16			-			
MK-SBC-N415D2201		3" NPT female	24	25		AISI 316	-		
MK-SBC-N517D2201		4" NPT female	38				1.70		
MK-SBC-N104D4401		1" NPT female	4.8				2.60		
MK-SBC-N211D4401		2" NPT female	13	7.40					
MK-SBC-N313D4401		2.1/2" NPT female	22	8.50					
MK-SBC-N415D4401		3" NPT female	33	15.50					
MK-SBC-N517D4401		4" NPT female	52	32.00					
MK-SBC-NV124D4401		5" NPT female	81	46.80					
MK-SBC-N6111D4401	6" NPT female	92	-						
MK-SBC-N8117D4401	8" NPT female	165	-						
	MK-SBC-N123D1101	DN25 PN10/16	3.2	16	aluminium	FPM/ FKM	-	-	
	MK-SBC-N230D1101	DN50 PN10/16	9					2.50	
	MK-SBC-N333D1101	DN65 PN10/16	10					4.50	
	MK-SBC-N436D1101	DN80 PN10/16	15	10				5.10	
	MK-SBC-N539D1101	DN100 PN10/16	24					7.00	
	MK-SBC-N645D1101	DN150 PN10/16	54					19.60	
	MK-SBC-N123D2201	DN25 PN10/16	3.2	16	brass			-	
	MK-SBC-N230D2201	DN50 PN10/16	9					-	
	MK-SBC-N333D2201	DN65 PN10/16	16					-	
	MK-SBC-N436D2201	DN80 PN10/16	24	25				AISI 316	-
	MK-SBC-N539D2201	DN100 PN10/16	38						4.20
	MK-SBC-N123D4401	DN25 PN10/16	4.8						7.30
	MK-SBC-N230D4401	DN50 PN10/16	13	13.20					
	MK-SBC-N333D4401	DN65 PN10/16	22	15.10					
	MK-SBC-N436D4401	DN80 PN10/16	33	20.70					
	MK-SBC-N539D4401	DN100 PN10/16	52	57.60					
	MK-SBC-N645D4401	DN150 PN10/16	92	71.00					
	MK-SBC-N8103D4401	DN200 PN16	165	16					

INDUSTRIAL FITTINGS - couplings

Emergency couplings - SBC

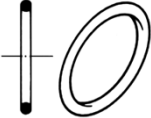
picture	code	connection	breaking force [kN]	material
	MK-SBC-S-N1D-44-3.2	1" BSP female	3.2	AISI 316
	MK-SBC-S-N1D-44-4.8	1" BSP female	4.8	
	MK-SBC-S-N2D-44-9.0	2" BSP female	9	
	MK-SBC-S-N2D-44-13.0	2" BSP female	13	
	MK-SBC-S-N3D-44-10.0	2.1/2" BSP female	10	
	MK-SBC-S-N3D-44-16.0	2.1/2" BSP female	16	
	MK-SBC-S-N3D-44-22.0	2.1/2" BSP female	22	
	MK-SBC-S-N4D-44-15.0	3" BSP female	15	
	MK-SBC-S-N4D-44-24.0	3" BSP female	24	
	MK-SBC-S-N4D-44-33.0	3" BSP female	33	
	MK-SBC-S-N5D-44-24.0	4" BSP female	24	
	MK-SBC-S-N5D-44-38.0	4" BSP female	38	
	MK-SBC-S-N5D-44-52.0	4" BSP female	52	
	MK-SBC-S-NVD-44-37.0	5" BSP female	37	
	MK-SBC-S-NVD-44-81.0	5" BSP female	81	
	MK-SBC-S-N6D-44-54.0	6" BSP female	54	
MK-SBC-S-N6D-44-92.0	6" BSP female	92		
MK-SBC-S-N8D-44-165.0	8" BSP female	165		
	MK-SBC-O-N1D-01	1" BSP female	-	FPM/FKM
	MK-SBC-O-N2D-01	2" BSP female	-	
	MK-SBC-O-N3D-01	2.1/2" BSP female	-	
	MK-SBC-O-N4D-01	3" BSP female	-	
	MK-SBC-O-N5D-01	4" BSP female	-	
	MK-SBC-O-NVD-01	5" BSP female	-	
	MK-SBC-O-N6D-01	6" BSP female	-	
	MK-SBC-O-N8D-013	8" BSP female	-	
Spanner	MK-SBC-TOOL020	1.1/2" - 4"	-	-
Set of spare O-rings	MK-SBC-TOOL001	-	-	-

SBC coupling versions



with swivel joint



with DDC coupler

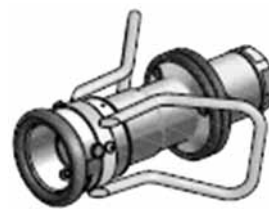

with DGC coupler

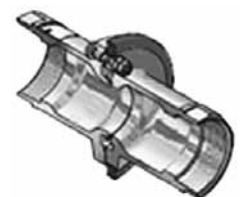

without valves

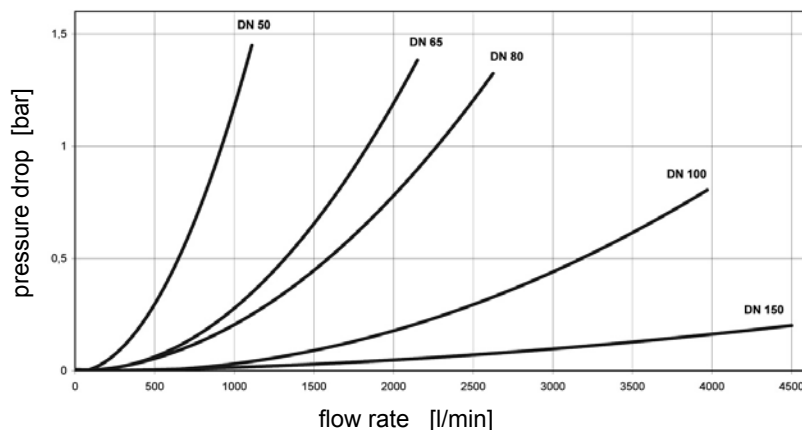

Test parameters:

Medium: n-paraffin
 Temperature: +20°C
 Density: 0.75 kg/dm³
 Viscosity: 1.75 mm²/s

INDUSTRIAL FITTINGS - couplings

Emergency couplings - ABV



Material: SS (AISI 316 / AISI 316Ti),
SS/ECTFE, Al

Seal: Viton - O-ring
PTFE - for SS couplings,
PUR - for Al couplings
(other also available)

Connections: BSP female thread

Working press.: 16 bar (10 bar for Al)

Working temp.: From -40°C up to +150°C (for SS)
From -40°C up to +60°C (for Al)

Operation

A coupling designed to transmit a load of a strained hose to breaking bolts. The bolts are broken before the hose and its fittings collapse. The coupling disconnects. Simultaneously spring valves in both coupling halves lock so the transferred medium is not released to the atmosphere. The coupling contains three breaking pins that ensure even distribution of axial load. If the load is lateral, the coupling disconnects earlier. The lateral deflection of the force straining the hose from the coupling axis must not exceed 90°. After emergency situation which caused disconnection of the coupling and breaking of bolts, the coupling can be easily connected using a new set of bolts. However before it is reused, the coupling always requires meticulous inspection.

Application

ABV emergency couplings are used in industrial installations and reloading systems, to handle chemicals, fuels and gases.

Standards

Compliant with the Pressure Equipment Directive (CE marking) and the ATEX Directive for operation in potentially explosive atmospheres, zone 1.

Axial force (P) breaking a coupling without pressure

DN [mm]	25	50	80	100
P [kG]	320	1000	2000	2800

Pressure drop in ABV and ABV-S couplings

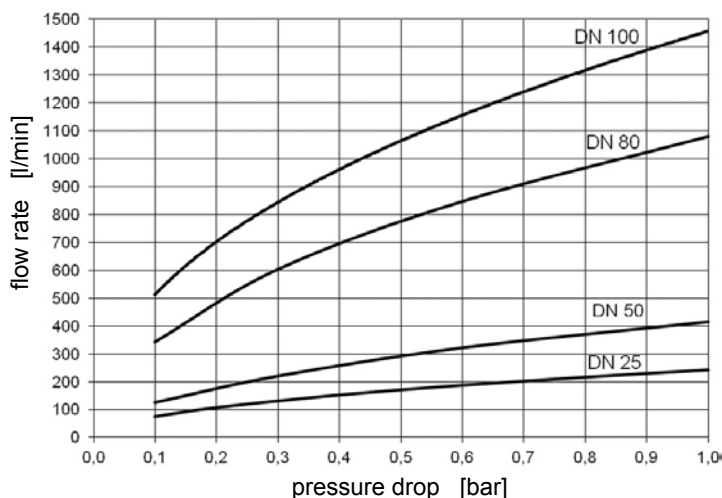

Test parameters:

Medium: water
Temperature: +20°C
DIN EN 60534-2-3

Resistance of a flexible hose assembly (a hose with fittings) to axial mechanical load must be at least 1.3 times bigger than the force breaking a coupling.

INDUSTRIAL FITTINGS - couplings

Emergency couplings - ABV

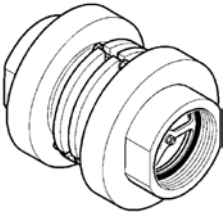
picture	code	connection	break. force [kN]	work. press. [bar]	material	seal		weight [kg]
						O-ring	thread	
	RS-555100100141	1" BSP female	3.2	10	aluminium		PUR	-
	RS-555200200141	2" BSP female	10					1.20
	RS-555300300141	3" BSP female	20					3.40
	RS-555400400141	4" BSP female	28					5.20
	RS-555100100121	1" BSP female	3.2		AISI 316Ti		Viton	1.20
	RS-555200200121	2" BSP female	10					2.40
	RS-555300300121	3" BSP female	20					5.90
	RS-555400400121	4" BSP female	28					10.00
	RS-55510010012174	1" BSP female	3.2		AISI 316Ti /C4 ECTFE		PTFE	-
	RS-55520020012174	2" BSP female	10					2.40
	RS-55530030012174	3" BSP female	20					5.90
	RS-55540040012174	4" BSP female	28					10.00
	RS-55510010012109	1" BSP female	3.2		AISI 316		EPDM	1.20
	RS-55520020012109	2" BSP female	10					2.40
	RS-55530030012109	3" BSP female	20					5.90
	RS-55540040012109	4" BSP female	28					10.00
	RS-55510010012179	1" BSP female	3.2		AISI 316Ti /C4 ECTFE		EPDM	-
	RS-55520020012179	2" BSP female	10					2.40
RS-55530030012179	3" BSP female	20	5.90					
RS-55540040012179	4" BSP female	28	9.80					

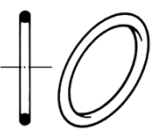
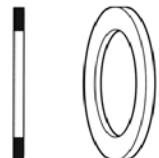
picture	code	connection	breaking force [kN]	material
	RS-550006025042	1"	3.2	AISI 316
	RS-550006025102	2"	10	
	RS-550006025202	3"	20	
	RS-550008035282	4"	28	
	RS-06502300300402	1"	-	Viton
	RS-06501800200402			
	RS-06503900300402	2"		
	RS-06506500400401	3"		
	RS-06508000400401	4"		
	RS-06508500400401			
	RS-010200000102	2"	-	PUR
	RS-010300000102	3"		
	RS-010400000102	4"		
	RS-010100000106	1"		
	RS-010200000106	2"		PTFE
	RS-010300000106	3"		
	RS-010400000106	4"		

INDUSTRIAL FITTINGS - couplings

Emergency couplings - ABV-S



Material: SS (AISI 316 / AISI 316Ti),
SS/ECTFE

Seal: Viton - O-ring
PTFE - for SS couplings
(other also available)

Connections: BSP female thread
DIN PN10/16 or ASA 150 flanges

Working press.: 25 bar

Working temp.: From -40°C up to +150°C
(working temperature depends on seal
and coupling material)

Operation

A coupling with a cable activates disconnection when a hose assembly connected to a tank truck is pulled. At the same time the cable fixed to the coupling at one end and at the other to a rigid point on the installation is strained (the cable is shorter than the flexible hose assembly). The coupling disconnects. Simultaneously spring valves in both coupling halves lock so the transferred medium is not discharged to the atmosphere. The coupling has three levers that connect coupling halves. The levers are released when the strain of the cable achieves pre-determined limit. The lateral deflection of the force straining the cable from the coupling axis must not exceed 90°. After emergency situation which caused disconnection of the coupling, the coupling can be connected once again. However before it is reused, the coupling always requires thorough inspection.

Application

ABV-S emergency couplings are used in industrial installations and reloading systems, to handle chemicals, fuels and gases. Compared to ABV couplings with breaking bolts, ABV-S couplings are more adjustable so can be activated with little force. Thus they can be used on installations that cannot handle excessive loads. When compared: ABV DN 50 coupling activates at 7.8 kN (pressure: 16 bar, angle: 0°), whereas ABV-S DN 50 at 0.3 kN (pressure: 25 bar, angle: 0°).

Standards

Compliant with the Pressure Equipment Directive (CE marking) and the ATEX Directive for operation in potentially explosive atmospheres, zone 1.

**Force (P) that strains a cable
and causes coupling disconnection
at 25 bar:**

DN [mm]	P [kN]	
	angle 0°	angle 90°
25	0.4	0.5
50	0.3	0.6
80	0.5	0.9
100	1.5	1.8
150	2.4	4.9
200	3	6.3

Pressure drop in ABV-S coupling

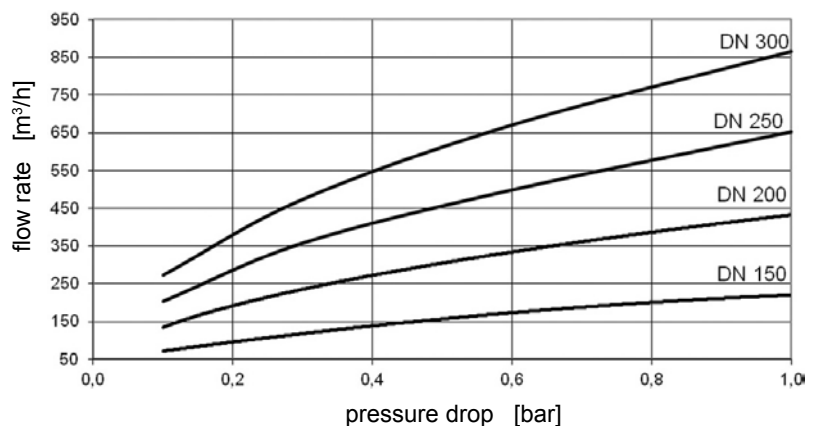



Test parameters:

Medium: water
Temperature: +20°C
DIN EN 60534-2-3

INDUSTRIAL FITTINGS - couplings

Emergency couplings - ABV-S

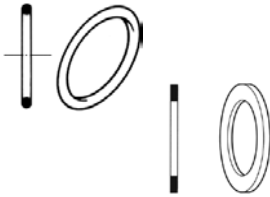
picture	code	connection	work. press. [bar]	material	seal		weight [kg]
					O-ring	thread	
	RS-556100100121	1" BSP female	25	AISI 316	Viton	PTFE	1.15
	RS-556200200121	2" BSP female					3.85
	RS-556300300121	3" BSP female					7.95
	RS-556400400121	4" BSP female					14.35
	RS-55610010012174	1" BSP female					1.15
	RS-55620020012174	2" BSP female		3.85			
	RS-55630030012174	3" BSP female		7.95			
	RS-55640040012174	4" BSP female		14.35			
	RS-55610010012109	1" BSP female		1.15			
	RS-55620020012109	2" BSP female		3.85			
	RS-55630030012109	3" BSP female		7.95			
	RS-55640040012109	4" BSP female		14.35			
	RS-55610010012110	1" BSP female		1.15			
	RS-55620020012110	2" BSP female		3.85			
	RS-55630030012110	3" BSP female		7.95			
RS-55640040012110	4" BSP female	14.35					
	RS-553600600220	DN 150 PN10/16	16	AISI 316	Viton	-	37.50
	RS-553600600720	6" ASA 150 PSI	41.10				
	RS-553600600420	DN 150 PN25	25				41.50
	RS-553600600820	6" ASA 300 PSI	10				49.10
	RS-553800800120	DN 200 PN10	10				98.40
	RS-553800800220	DN 200 PN16	16				98.40
	RS-553800800720	8" ASA 150 PSI	102.30				
Set of flat seals and O-rings 	RS-550200200104	DN 50	-	-	Viton	PTFE	-
	RS-550200200105				EPDM		
	RS-550200200106				FEP		
	RS-550300300104	DN 80			Viton		
	RS-550300300106				FEP		
	RS-550400400104	DN 100			Viton		
	RS-550400400106				FEP		
	RS-550600600004	DN 150			Viton		
	RS-550600600006				FEP		
	RS-550800800004	DN 200			Viton		
Protection ring	RS-554050200003	DN 50	-	PE	-	-	-
	RS-554080300003	DN 80	-	PE	-	-	-
	RS-554100400003	DN 100	-	PE	-	-	-

INDUSTRIAL FITTINGS - couplings

Emergency couplings - ABVL



Material: SS (AISI 316Ti / AISI 316), Al
Seal: O-ring: Viton (options: NBR, EPDM, Kalrez)
 Flat seal: PTFE
Connections: Standard - BSP female thread
 Options - NPT female thread, BSP male thread, EN 1092, ASME flanges, weld-in ends
Size: DN50, DN80, DN100, DN150
Working press.: 25 bar
Working temp.: From -40°C up to +150°C

Operation

ABVL emergency coupling is an upgraded version of ABV coupling. The coupling protects against consequences of accidental, excessive strain of a hose assembly connected to an installation e.g. during reloading, when a tank truck rolls away and the hose is still connected. Before the hose is strained so much that it breaks or the fittings are torn off, the bolts joining both halves are broken so that the coupling disconnects. Simultaneously the valves in both coupling halves lock so the transferred medium is not released to the atmosphere. If the load is lateral, the coupling disconnects earlier. The lateral deflection of the force straining the hose from the coupling axis must not exceed 90°. The main advantage of ABVL couplings over ABV couplings is low pressure loss at high flow rates obtained by the valves of special, streamlined construction.

Application

ABVL emergency couplings are used in industrial installations and reloading systems, to handle chemicals, fuels and gases.

Standards:

Compliant with the Pressure Equipment Directive (CE marking) and the ATEX Directive for operation in potentially explosive atmospheres.

Axial force (P) breaking a coupling

DN [mm]	coupling break force [kN] - 0 bar	coupling break force [kN] - 16 bar	recommend. hose break force [kN]
50	12	8.8	16
80	22	14.7	30
100	30	19.5	40
150	60	38.6	80

Comparison of pressure drop in ABVL/ASVL and ABV/ABV-S emergency couplings

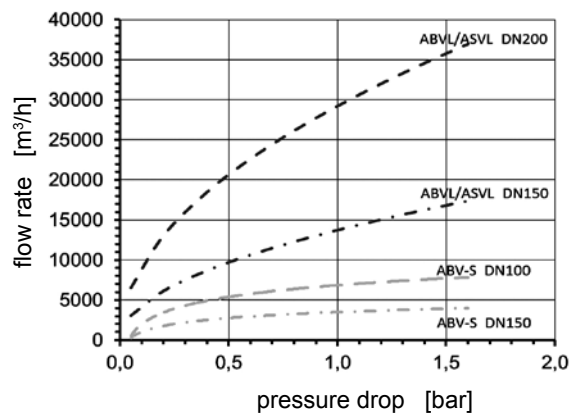
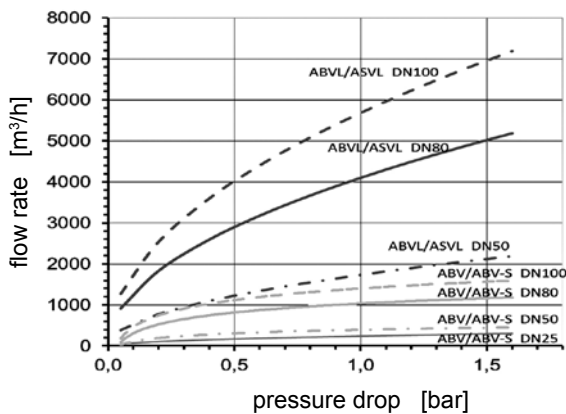

Test parameters: medium water, temperature +20°C.

INDUSTRIAL FITTINGS - couplings

Emergency couplings - ASVL

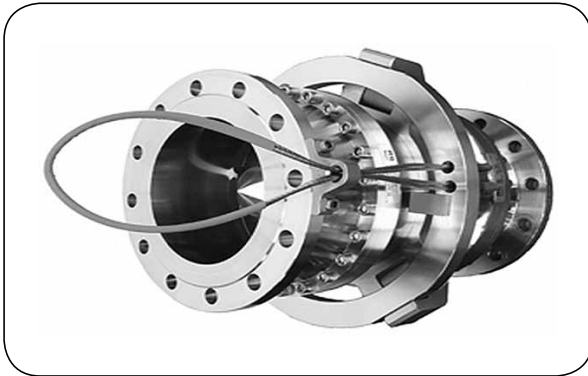

Material: SS (AISI 316Ti / AISI 316)
Seal: O-ring: Viton (options: NBR, EPDM, Kalrez)
 Flat seal: PTFE
Connections: Standard - BSP female thread
 Option - NPT female thread, BSP male thread, EN 1092, ASME flanges
Size: DN50, DN80, DN100, DN150, DN200
Working press.: 25 bar
Working temp.: From -40°C up to +150°C

Operation

ASVL emergency coupling is an upgraded version of ABV-S coupling. The coupling protect against consequences of accidental, excessive strain of a hose assembly connected to an installation e.g. during reloading, when a tank truck rolls away and the hose is still connected. When any displacement of a coupling connected to a tank truck occurs, the cable fixed to the coupling at one end and at the other to a rigid point on the installation is strained (the cable is shorter than the flexible hose assembly). The cable activates disconnection process. Simultaneously spring valves in both coupling halves lock, so the transferred medium is not discharged to the atmosphere. The coupling has three levers that connect coupling halves. The levers are released when the strain of the cable achieves pre-determined limit. The lateral deflection of the force straining the cable from the coupling axis must not exceed 90°. After emergency situation which caused disconnection of the coupling, the coupling can be connected again. However before it is reused, the coupling always requires thorough inspection. The main advantage of ASVL couplings over ABV-S couplings is low pressure loss at high flow rates obtained by the valves of special, streamlined construction.

Application

ASVL emergency couplings are used in industrial installations and reloading systems, to handle chemicals, fuels and gases.

Standards:

Compliant with the Pressure Equipment Directive (CE marking) and the ATEX Directive for operation in potentially explosive atmospheres.

Comparison of pressure drop in ABVL/ASVL and ABV/ABV-S emergency couplings

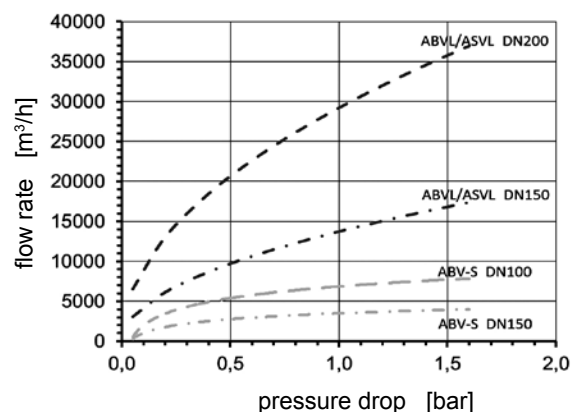
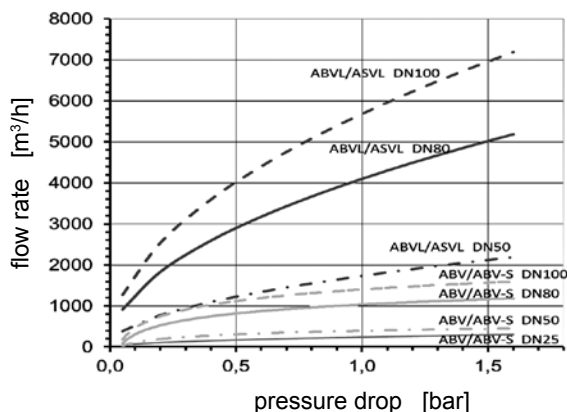

Test parameters: medium water, temperature +20°C.

INDUSTRIAL FITTINGS - couplings

Emergency couplings - KLAW



Material:	Stainless steel, carbon steel, aluminium
Seal:	Viton, PTFE
Connections:	BSP or BSPT thread, flanges, weld-in connectors
Sizes:	From 1" to 12"
Working press.:	Up to 40 bar (depends on a size)

Operation

KLAW emergency couplings protect against consequences of accidental, excessive strain of a flexible hose assembly connected to an installation. The coupling with breaking pins is designed to transmit the load of the strained hose to the pre-determined breaking bolts. The bolts are broken before the hose and its fittings collapse. The coupling disconnects. Simultaneously flap valves (Flip-Flap) in both coupling halves lock so the transferred medium is not released to the atmosphere. The coupling contains three breaking pins that ensure even distribution of axial load. If the load is lateral, the coupling disconnects earlier. The lateral deflection of the force straining the hose from the coupling axis must not exceed 90°. After emergency situation which caused disconnection of the coupling and breakage of bolts, the coupling can be easily connected using a new set of bolts. However before it is reused, the coupling always requires meticulous inspection.

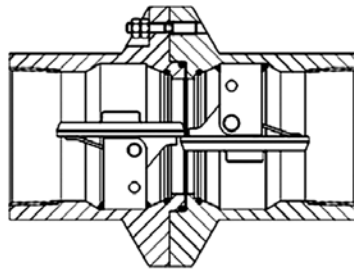

Available versions:

- MARINE - reloading in marine applications, assembled between two hose lengths,
- ERC - coupling with a cable, used with loading arms and other applications
- CRYOGENIC - for cryogenic media (down to -196°C - LNG, liquid oxygen, ethylene, propylene, ethane).

Application

KLAW emergency couplings are used in industrial installations and reloading systems, to handle chemicals, fuels and gases.

Standards

Compliant with the Pressure Equipment Directive (CE marking) and the ATEX Directive for operation in potentially explosive atmospheres, zone 1.

