

INDUSTRIAL FITTINGS - couplings

Dry disconnect couplings - DDC



- Material:** Aluminium, brass, AISI 316, titanium, PEEK, PVDF/Hastelloy, Hastelloy, Duplex
- Seals:** O-ring: FPM (Viton), EPDM, Chemraz, Kalrez, NBR
Flat seal: PTFE, FPM/FKM (Viton), PUR, Thermpac (HBD)
Other materials on request
- Connections:** BSP, NPT thread
ANSI 150, 300, PN EN 1092-1 flange
- Working temp.:** From -25°C up to +80°C

The acceptable working temperature ranges from -54°C up to +250°C, but as it depends on the medium, confirm the working temperature of each application with Technical Department of TUBES INTERNATIONAL®.

Operation

A hose unit (coupler) and a tank unit (adapter) of DDC type (Dry Disconnect Coupling) are both equipped with piston valves which can be opened only after the coupling is connected and closed before it is disconnected. It prevents spillage. The head of the hose unit is rotary (360°). To allow fluid flow, both units must be coupled by rotating the head of the hose unit about 100° clockwise. To stop the fluid flow, turn the head of the hose unit anticlockwise so the valves close and the coupling disconnects. A coded version of the coupling is also available. It prevents connecting the hose unit to the wrong tank unit, conveying other fluid. They are coded using slots of special dimension on the hose unit which mate only with pins on the corresponding tank unit.

Application

DDC couplings are widely used in road, rail, water and air transport, in petrochemical, chemical and pharmaceutical industry. They meet all requirements for safe, reliable and environment friendly transfer of hazardous, toxic or valuable products.

Standards

Manufactured according to NATO STANAG 3756 (DDC 2", 2.1/2", 3" and 4") and ATOFINA SGM 2049.TUY.C.(DDC 2", 3"). Meet the requirements of ATEX, TDT, ADR, RID, IMDG, Pressure Equipment Directive 97/23/WE. Approved by the European Chemical Industry Council - CEFIC.

Flow rate, maximum spillage at disconnection

size [inch]	1	2	2.1/2	3	4	6	8
DN [mm]	25	50	65	80	100	150	200
tank unit diameter [mm]	56	70	105	119	164	238	272
max. flow rate [l/min]	200	900	1500	2000	3500	6000	8000
max. spillage [ml]	0.5	0.5	1.1	1.33	2.2	-	-

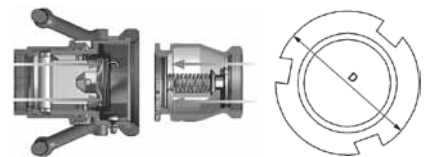

Pressure drop vs. flow rate

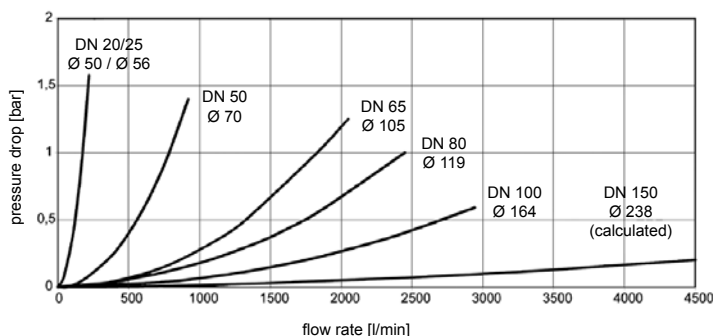

Test parameters:

Medium: n-paraffin
Temperature: +20°C
Density: 0.75 kg/dm³
Viscosity: 1.75 mm²/s
Stanag 3756. annex E

INDUSTRIAL FITTINGS - couplings

Dry disconnect couplings - DDC



Tank unit- size 1" (Ø 56)

picture	code	connection	work. press. [bar]	material	seal		weight [kg]			
					O-ring	thread				
	MK-DDC-T101A1101B	3/4" BSP	16	aluminium	FPM/ FKM	-	-			
	MK-DDC-T103A1101B	1" BSP								
	MK-DDC-T105A1101B	1.1/4" BSP								
	MK-DDC-T101A2201B	3/4" BSP		brass						
	MK-DDC-T103A2201B	1" BSP								
	MK-DDC-T105A2201B	1.1/4" BSP								
	MK-DDC-T101A4401A	3/4" BSP	25	AISI 316	FPM/ FKM	-	-			
	MK-DDC-T103A4401A	1" BSP								
	MK-DDC-T105A4401A	1.1/4" BSP								
	MK-DDC-T101A7701A	3/4" BSP		Hastelloy						
	MK-DDC-T103A7701A	1" BSP								
	MK-DDC-T105A7701A	1.1/4" BSP								
	MK-DDC-T101A9901A	3/4" BSP	6	PEEK	FPM/ FKM	-	-			
	MK-DDC-T103A9901A	1" BSP								
	MK-DDC-T105A9901A	1.1/4" BSP								
	MK-DDC-T169A1101	3/4" BSP	16	aluminium				FPM/ FKM	-	-
	MK-DDC-T171A1101	1" BSP								
	MK-DDC-T169A2201	3/4" BSP		brass						
	MK-DDC-T171A2201	1" BSP								
	MK-DDC-T169A4401	3/4" BSP	25		AISI 316					
	MK-DDC-T171A4401	1" BSP								
	MK-DDC-T123A1101	DN25 PN10/16	16	aluminium	FPM/ FKM	-	1.10			
	MK-DDC-T124A1101	DN25 PN25/40								
	MK-DDC-T151A1101	1" ASA 150								
	MK-DDC-T152A1101	1" ASA 300		brass						
	MK-DDC-T123A2201	DN25 PN10/16								
	MK-DDC-T124A2201	DN25 PN25/40								
	MK-DDC-T151A2201	1" ASA 150	25	AISI 316			-	-		
	MK-DDC-T152A2201	1" ASA 300								
	MK-DDC-T123A4401	DN25 PN10/16								
	MK-DDC-T124A4401	DN25 PN25/40								
	MK-DDC-T151A4401	1" ASA 150		Hastelloy						
	MK-DDC-T152A4401	1" ASA 300								
	MK-DDC-T123A7701	DN25 PN10/16								
	MK-DDC-T124A7701	DN25 PN25/40	6	PEEK			-	-		
	MK-DDC-T151A7701	1" ASA 150								
	MK-DDC-T152A7701	1" ASA 300								
	MK-DDC-T123A9901	DN25 PN10/16								
	MK-DDC-T124A9901	DN25 PN25/40								
MK-DDC-T151A9901	1" ASA 150									
MK-DDC-T152A9901	1" ASA 300									
	MK-DDC-C100A2201	-	-	composite	FPM/ FKM	-	0.13			
	MK-DDC-C100A1101	-	-	aluminium			0.22			
	MK-DDC-C100A4401	-	-	AISI 316			0.59			
Repair kit set of O-rings	MK-DDC-O-T1-01	-	-	FPM/FKM	-	-	-			
Repair kit flat seal	MK-1498-09	3/4" BSP	-	PUR	-	-	-			
	MK-1498-06			PTFE						
	MK-1220-09	1" BSP		PUR						
	MK-1220-06			PTFE						
	MK-1536-09	1.1/4" BSP		PUR						
	MK-1536-06			PTFE						
Set of spare parts	MK-DDC-S-T1-11	-	16	aluminium	-	-	-			
	MK-DDC-S-T1-22			brass						
	MK-DDC-S-T1-44		25	AISI 316						

INDUSTRIAL FITTINGS - couplings

Dry disconnect couplings - DDC

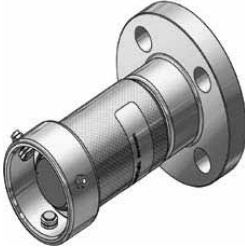

Hose unit - size 1" (Ø 56)

picture	code	connection	work. press. [bar]	material	seal		weight [kg]	
					O-ring	thread		
	MK-DDC-S101A1101B	3/4" BSP	16	aluminium	FPM/ FKM	-	PUR	
	MK-DDC-S103A1101B	1" BSP						
	MK-DDC-S105A1101B	1.1/4" BSP						
	MK-DDC-S101A2201B	3/4" BSP		brass				
	MK-DDC-S103A2201B	1" BSP						
	MK-DDC-S105A2201B	1.1/4" BSP						
	MK-DDC-S101A4401A	3/4" BSP	25	AISI 316	FPM/ FKM	-	PTFE	
	MK-DDC-S103A4401A	1" BSP						
	MK-DDC-S105A4401A	1.1/4" BSP						
	MK-DDC-S101A7701A	3/4" BSP		Hastelloy				
	MK-DDC-S103A7701A	1" BSP						
	MK-DDC-S105A7701A	1.1/4" BSP						
	MK-DDC-S101A9901A	3/4" BSP	6	PEEK	-	-	0.30	
	MK-DDC-S103A9901A	1" BSP						
MK-DDC-S105A9901A	1.1/4" BSP							
	MK-DDC-S123A1101	DN25 PN10/16	16	aluminium	FPM/ FKM	-	1.10	
	MK-DDC-S124A1101	DN25 PN25/40						
	MK-DDC-S151A1101	1" ASA 150						
	MK-DDC-S152A1101	1" ASA 300		brass				
	MK-DDC-S123A2201	DN25 PN10/16						
	MK-DDC-S124A2201	DN25 PN25/40						
	MK-DDC-S151A2201	1" ASA 150	25	AISI 316			-	2.20
	MK-DDC-S152A2201	1" ASA 300						
	MK-DDC-S123A4401	DN25 PN10/16						
	MK-DDC-S124A4401	DN25 PN25/40						
	MK-DDC-S151A4401	1" ASA 150		Hastelloy				
	MK-DDC-S152A4401	1" ASA 300						
	MK-DDC-S123A7701	DN25 PN10/16						
	MK-DDC-S124A7701	DN25 PN25/40	6	PEEK			-	2.50
	MK-DDC-S151A7701	1" ASA 150						
	MK-DDC-S152A7701	1" ASA 300						
	MK-DDC-S123A9901	DN25 PN10/16						
	MK-DDC-S124A9901	DN25 PN25/40						
MK-DDC-S151A9901	1" ASA 150							
MK-DDC-S152A9901	1" ASA 300							
	MK-DDC-P100A2201			composite	FPM/ FKM	-	0.06	
	MK-DDC-P100A1101	-	-	aluminium			-	0.12
	MK-DDC-P100A4401			AISI 316				0.32
Repair kit flat seal	MK-DDC-O-S1-01	-	-	FPM/FKM	-	-		
Repair kit flat seal	MK-1498-09	3/4" BSP	-	PUR	-	-	0.001	
	MK-1498-06			PTFE				
	MK-1220-09	1" BSP		PUR			0.002	
	MK-1220-06			PTFE				
	MK-1536-09	1.1/4" BSP		PUR			0.001	
	MK-1536-06			PTFE			0.003	
Set of spare parts	MK-DDC-S-S1-11	-	16	aluminium	-	-	-	
	MK-DDC-S-S1-22			brass				
	MK-DDC-S-S1-44		25	AISI 316				

INDUSTRIAL FITTINGS - couplings

Dry disconnect couplings - DDC

Tank unit - size 2" (Ø 70)

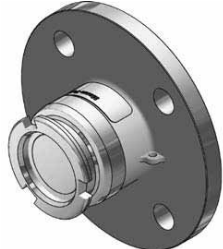
picture	code	connection	work. press. [bar]	material	seal		weight [kg]	
					O-ring	thread		
	MK-DDC-T207A1101B	1.1/2 BSP	16	aluminium	FPM/ FKM	PUR	-	
	MK-DDC-T210A1101B	2" BSP		brass				
	MK-DDC-T207A2201B	1.1/2 BSP						25
	MK-DDC-T210A2201B	2" BSP		Hastelloy				
	MK-DDC-T207A4401A	1.1/2 BSP	6	PEEK		PTFE		
	MK-DDC-T210A4401A	2" BSP						
	MK-DDC-T207A7701A	1.1/2 BSP						
	MK-DDC-T210A7701A	2" BSP						
	MK-DDC-T207A9901A	1.1/2 BSP	6	PEEK	PTFE			
MK-DDC-T210A9901A	2" BSP							
	MK-DDC-T278A1101	2" BSP	16	aluminium	FPM/ FKM	-	-	
	MK-DDC-T278A2201	2" BSP		brass				
	MK-DDC-T278A4401	2" BSP	25	AISI 316				
	MK-DDC-T227B1101	DN40 PN10/16	16	aluminium	FPM/ FKM	-	-	
	MK-DDC-T230B1101	DN50 PN10/16						
	MK-DDC-T255B1101	1.1/2" ASA 150						
	MK-DDC-T257B1101	2" ASA 150						
	MK-DDC-T227B2201	DN40 PN10/16						
	MK-DDC-T228B2201	DN40 PN25/40						
	MK-DDC-T255B2201	1.1/2" ASA 150						
	MK-DDC-T256B2201	1.1/2" ASA 300						
	MK-DDC-T230B2201	DN50 PN10/16						
	MK-DDC-T231B2201	DN50 PN25/40						
	MK-DDC-T257B2201	2" ASA 150						
	MK-DDC-T258B2201	2" ASA 300						
	MK-DDC-T227B4401	DN40 PN10/16		25				AISI 316
	MK-DDC-T228B4401	DN40 PN25/40						
	MK-DDC-T255B4401	1.1/2" ASA 150						
	MK-DDC-T256B4401	1.1/2" ASA 300						
	MK-DDC-T230B4401	DN50 PN10/16						
	MK-DDC-T231B4401	DN50 PN25/40						
	MK-DDC-T257B4401	2" ASA 150						
	MK-DDC-T258B4401	2" ASA 300						
	MK-DDC-T227A7701	DN40 PN10/16	Hastelloy					
	MK-DDC-T228A7701	DN40 PN25/40						
	MK-DDC-T255A7701	1.1/2" ASA 150						
	MK-DDC-T256A7701	1.1/2" ASA 300						
	MK-DDC-T230A7701	DN50 PN10/16						
	MK-DDC-T231A7701	DN50 PN25/40						
	MK-DDC-T257A7701	2" ASA 150						
	MK-DDC-T258A7701	2" ASA 300						
	MK-DDC-T227A9901	DN40 PN10/16	6	PEEK				
	MK-DDC-T255A9901	1.1/2" ASA 150						
	MK-DDC-T230A9901	DN50 PN10/16						
	MK-DDC-T257A9901	2" ASA 150						



INDUSTRIAL FITTINGS - couplings

Dry disconnect couplings - DDC

Tank unit - size 2" (Ø 70)

picture	code	connection	work. press. [bar]	material	seal		weight [kg]
					O-ring	thread	
	MK-DDC-C200E2202	-	-	composite	NBR	-	-
	MK-DDC-C200A1101			aluminium	FPM/FKM		
	MK-DDC-C200B4401			AISI 316			
	MK-DDC-C200D1300			NBR/PVC			
Repair kit set of O-rings	MK-DDC-O-T2-01	-	-	FPM/FKM	-	-	-
Repair kit flat seal	MK-1196-09	1.1/2" BSP	-	PUR	-	-	0.002
	MK-1196-06			PTFE			0.003
	MK-1052-09	2" BSP		PUR			0.004
	MK-1052-06			PTFE			
Set of spare parts	MK-DDC-S-T2-11	-	16	aluminium	-	-	-
	MK-DDC-S-T2-22		brass				
	MK-DDC-S-T2-44		25	AISI 316			



Hose unit - size 2" (Ø 70)

picture	code	connection	work. press. [bar]	material	seal		weight [kg]
					O-ring	thread	
	MK-DDC-S207A1101B	1.1/2" BSP	16	aluminium	FPM/FKM	PUR	-
	MK-DDC-S210A1101B	2" BSP					
	MK-DDC-S207A2201B	1.1/2" BSP		brass			
	MK-DDC-S210A2201B	2" BSP	25	AISI 316		PTFE	
	MK-DDC-S207A4401A	1.1/2" BSP					
	MK-DDC-S210A4401A	2" BSP		Hastelloy			
	MK-DDC-S207A7701A	1.1/2" BSP	6	PEEK			
	MK-DDC-S210A7701A	2" BSP					
	MK-DDC-S207A9901A	1.1/2" BSP					
MK-DDC-S210A9901A	2" BSP						
	MK-DDC-S278A1101	2" BSP	16	aluminium	FPM/FKM	-	-
	MK-DDC-S278A2201	2" BSP		brass			
	MK-DDC-S278A4401	2" BSP	25	AISI 316			
	MK-DDC-S227A1101	DN40 PN10/16	16	aluminium	FPM/FKM	-	-
	MK-DDC-S230A1101	DN50 PN10/16					
	MK-DDC-S255A1101	1.1/2" ASA 150					
	MK-DDC-S256A1101	1.1/2" ASA 300					
	MK-DDC-S227A2201	DN40 PN10/16					
	MK-DDC-S228A2201	DN40 PN25/40					
	MK-DDC-S255A2201	1.1/2" ASA 150		bronze			
	MK-DDC-S256A2201	1.1/2" ASA 300					
	MK-DDC-S230A2201	DN50 PN10/16					
	MK-DDC-S231A2201	DN50 PN25/40					
	MK-DDC-S257A2201	2" ASA 150					
	MK-DDC-S258A2201	2" ASA 300					
	MK-DDC-S227A4401	DN40 PN10/16	25	AISI 316			
	MK-DDC-S228A4401	DN40 PN25/40					
	MK-DDC-S255A4401	1.1/2" ASA 150					
	MK-DDC-S256A4401	1.1/2" ASA 300					
MK-DDC-S230A4401	DN50 PN10/16						
MK-DDC-S231A4401	DN50 PN25/40						
MK-DDC-S257A4401	2" ASA 150						
MK-DDC-S258A4401	2" ASA 300						



INDUSTRIAL FITTINGS - couplings

Dry disconnect couplings - DDC

Hose unit - size 2" (Ø 70)

picture	code	connection	work. press. [bar]	material	seal		weight [kg]
					O-ring	thread	
	MK-DDC-S227A7701	DN40 PN10/16	25	Hastelloy	FPM/ FKM	-	-
	MK-DDC-S228A7701	DN40 PN25/40					
	MK-DDC-S255A7701	1.1/2" ASA 150					
	MK-DDC-S256A7701	1.1/2" ASA 300					
	MK-DDC-S230A7701	DN50 PN10/16					
	MK-DDC-S231A7701	DN50 PN25/40					
	MK-DDC-S257A7701	2" ASA 150					
	MK-DDC-S258A7701	2" ASA 300					
	MK-DDC-S227A9901	DN40 PN10/16	6	PEEK	-	-	
	MK-DDC-S255A9901	1.1/2" ASA 150					
	MK-DDC-S230A9901	DN50 PN10/16					
	MK-DDC-S257A9901	2" ASA 150					
	MK-DDC-P200A2201	-	-	composite	FPM/ FKM	-	-
	MK-DDC-P200A1101			aluminium			
	MK-DDC-P200A4401			AISI 316			
Repair kit set of O-rings	MK-DDC-O-S2-01	-	-	FPM/FKM	-	-	-
Repair kit flat seal	MK-1196-09	1.1/2 BSP	-	PUR	-	-	0.002
	MK-1196-06			PTFE			0.003
	MK-1052-09	2" BSP		PUR			0.003
	MK-1052-06			PTFE			0.004
Set of spare parts	MK-DDC-S-S2-11	-	16	aluminium	-	-	-
	MK-DDC-S-S2-22			brass			
	MK-DDC-S-S2-44		25	AISI 316			



Tank unit - size 2.1/2" (Ø 105)

picture	code	connection	work. press. [bar]	material	seal		weight [kg]	
					O-ring	thread		
	MK-DDC-T312D1101B	2.1/2" BSP	10	aluminium	FPM/ FKM	-	-	
	MK-DDC-T314D1101B	3" BSP						
	MK-DDC-T312D2201B	2.1/2" BSP	16	bronze				PUR
	MK-DDC-T314D2201B	3" BSP						
	MK-DDC-T312B4401A	2.1/2" BSP	25	AISI 316	-	-		
	MK-DDC-T314B4401A	3" BSP						
	MK-DDC-T312A7701A	2.1/2" BSP					Hastelloy	
	MK-DDC-T314A7701A	3" BSP						
	MK-DDC-T312A9901A	2.1/2" BSP	6	PEEK	-	-		
	MK-DDC-T314A9901A	3" BSP						
	MK-DDC-T380A1101	2.1/2" BSP	10	aluminium	FPM/ FKM	-	-	
	MK-DDC-T382A1101	3" BSP						
	MK-DDC-T380A2201	2.1/2" BSP	16	brass				
	MK-DDC-T382A2201	3" BSP						
	MK-DDC-T380A4401	2.1/2" BSP	25	AISI 316				
	MK-DDC-T382A4401	3" BSP						
	MK-DDC-T333D1101	DN65 PN10/16	10	aluminium	FPM/ FKM	-	-	
	MK-DDC-T336D1101	DN80 PN10/16						
	MK-DDC-T359D1101	2.1/2" ASA 150						
	MK-DDC-T361D1101	3" ASA 150						
	MK-DDC-T333D2201	DN65 PN10/16	16	bronze				
	MK-DDC-T334D2201	DN65 PN25/40						
	MK-DDC-T336D2201	DN80 PN10/16						
	MK-DDC-T337D2201	DN80 PN25/40						
	MK-DDC-T359D2201	2.1/2" ASA 150						



INDUSTRIAL FITTINGS - couplings

Dry disconnect couplings - DDC

Tank unit - size 2.1/2" (Ø 105)

picture	code	connection	work. press. [bar]	material	seal		weight [kg]
					O-ring	thread	
	MK-DDC-T360D2201	2.1/2" ASA 300	16	bronze	FPM/ FKM	-	-
	MK-DDC-T361D2201	3" ASA 150					
	MK-DDC-T362D2201	3" ASA 300					
	MK-DDC-T367D2201	TTMA 3"					
	MK-DDC-T368D2201	TTMA 4"					
	MK-DDC-T333B4401	DN65 PN10/16	25	AISI 316			
	MK-DDC-T334B4401	DN65 PN25/40					
	MK-DDC-T336B4401	DN80 PN10/16					
	MK-DDC-T337B4401	DN80 PN25/40					
	MK-DDC-T359B4401	2.1/2" ASA 150					
	MK-DDC-T360B4401	2.1/2" ASA 300					
	MK-DDC-T361B4401	3" ASA 150					
	MK-DDC-T362B4401	3" ASA 300					
	MK-DDC-T367B4401	TTMA 3"					
MK-DDC-T368B4401	TTMA 4"						
	MK-DDC-C300E2202	-	-	composite	NBR	-	-
	MK-DDC-C300B1101			aluminium	FPM/ FKM		
	MK-DDC-C300B4401			AISI 316	FPM/ FKM		
Repair kit set of O-rings	MK-DDC-O-T3-01	-	-	FPM/FKM	-	-	-
Repair kit flat seal	MK-1181-09	2.1/2" BSP	-	PUR	-	-	0.005
	MK-1181-06			PTFE			0.006
	MK-1110-09	3" BSP		PUR			0.006
	MK-1110-06			PTFE			0.007
Set of spare parts	MK-DDC-S-T3-11	-	10	aluminium	-	-	-
	MK-DDC-S-T3-22		16	brass			
	MK-DDC-S-T3-44		25	AISI 316			

Hose unit - size 2.1/2" (Ø 105)

picture	code	connection	work. press. [bar]	material	seal		weight [kg]		
					O-ring	thread			
	MK-DDC-S312B1101B	2.1/2" BSP	10	aluminium	FPM/ FKM	-	-		
	MK-DDC-S314B1101B	3" BSP							
	MK-DDC-S312B2201B	2.1/2" BSP	16	bronze				PUR	
	MK-DDC-S314B2201B	3" BSP							
	MK-DDC-S312B4401A	2.1/2" BSP	25	AISI 316				PTFE	
	MK-DDC-S314B4401A	3" BSP							
	MK-DDC-S312A7701A	2.1/2" BSP							Hastelloy
	MK-DDC-S314A7701A	3" BSP							
	MK-DDC-S312A9901A	2.1/2" BSP	6	PEEK					
	MK-DDC-S314A9901A	3" BSP							
	MK-DDC-P300A2201	-	-	composite	FPM/ FKM	-	-		
	MK-DDC-P300A1101			aluminium					
	MK-DDC-P300A4401			AISI 316					
Repair kit set of O-rings	MK-DDC-O-S3-01	-	-	FPM/FKM	-	-	-		
Repair kit flat seal	MK-1181-09	2.1/2" BSP	-	PUR	-	-	0.005		
	MK-1181-06			PTFE			0.006		
	MK-1110-09	3" BSP		PUR			0.006		
	MK-1110-06			PTFE			0.007		
Set of spare parts	MK-DDC-S-S3-11	-	10	aluminium	-	-	-		
	MK-DDC-S-S3-22		16	brass					
	MK-DDC-S-S3-44		25	AISI 316					

INDUSTRIAL FITTINGS - couplings

Dry disconnect couplings - DDC



Tank unit - size 3" (Ø 119)

picture	code	connection	work. press. [bar]	material	seal		weight [kg]
					O-ring	thread	
	MK-DDC-T414D1101B	3" BSP	10	aluminium	FPM/ FKM	PUR	-
	MK-DDC-T414D2201B	3" BSP	16	bronze			
	MK-DDC-T414B4401A	3" BSP	25	AISI 316		PTFE	3.06
	MK-DDC-T414A7701A	3" BSP		Hastelloy			-
	MK-DDC-T414A8701A	3" BSP		PVDF Hastelloy			
	MK-DDC-T414A9901A	3" BSP	6	PEEK			
	MK-DDC-T433D1101	DN65 PN10/16	10	aluminium	FPM/ FKM	-	-
	MK-DDC-T436D1101	DN80 PN10/16					
	MK-DDC-T461D1101	3" ASA 150					
	MK-DDC-T467D1101	TTMA 3"					
	MK-DDC-T468D1101	TTMA 4"					
	MK-DDC-T433D2201	DN65 PN10/16	16	bronze			
	MK-DDC-T434D2201	DN65 PN25/40					
	MK-DDC-T436D2201	DN80 PN10/16					
	MK-DDC-T437D2201	DN80 PN25/40					
	MK-DDC-T461D2201	3" ASA 150					
	MK-DDC-T462D2201	3" ASA 300					
	MK-DDC-T467D2201	TTMA 3"					
	MK-DDC-T468D2201	TTMA 4"					
	MK-DDC-T433B4401	DN65 PN10/16	25	AISI 316			
	MK-DDC-T434B4401	DN65 PN25/40					
	MK-DDC-T436B4401	DN80 PN10/16					
	MK-DDC-T437B4401	DN80 PN25/40					
	MK-DDC-T461B4401	3" ASA 150					
	MK-DDC-T462B4401	3" ASA 300					
	MK-DDC-T467B4401	TTMA 3"					
	MK-DDC-T468B4401	TTMA 4"					
	MK-DDC-T436A9901	DN80 PN10/16	6	PEEK			
	MK-DDC-T461A9901	3" ASA 150					
MK-DDC-T467A9901	TTMA 3"						
MK-DDC-T468A9901	TTMA 4"						
	MK-DDC-C400E2202	-	-	composite	FPM/ FKM	-	-
	MK-DDC-C400A1101			aluminium			
	MK-DDC-C400B4401			AISI 316			
	MK-DDC-C400D1300			NBR/PVC			
Repair kit set of O-rings	MK-DDC-O-T4-01	-	-	FPM/FKM	-	-	-
Repair kit flat seal	MK-1110-09	3" BSP	-	PUR	-	-	0.006
	MK-1110-06			PTFE			0.007
Set of spare parts	MK-DDC-S-T4-11	-	10	aluminium	-	-	-
	MK-DDC-S-T4-22		16	brass			
	MK-DDC-S-T4-44		25	AISI 316			



INDUSTRIAL FITTINGS - couplings

Dry disconnect couplings - DDC

Hose unit - size 3" (Ø 119)

picture	code	connection	work. press. [bar]	material	seal		weight [kg]
					O-ring	thread	
	MK-DDC-S414B1101B	3" BSP	10	aluminium	FPM/ FKM	PUR	-
	MK-DDC-S414B2201B	3"BSP	16	bronze			
	MK-DDC-S414B4401A	3"BSP	25	AISI 316		PTFE	8.65
	MK-DDC-S414A7701A	3" BSP		Hastelloy			
	MK-DDC-S414A8701A	3"BSP		PVDF/Hast.			
	MK-DDC-S414A9901A	3" BSP	6	PEEK			
	MK-DDC-S436B1101	DN80 PN10/16	10	aluminium	FPM/ FKM	-	-
	MK-DDC-S461B1101	3" ASA 150					
	MK-DDC-S467B1101	TTMA 3"					
	MK-DDC-S468B1101	TTMA 4"					
	MK-DDC-S436B2201	DN 80 PN10/16	16	bronze			
	MK-DDC-S437B2201	DN 80 PN25/40					
	MK-DDC-S461B2201	3" ASA 150					
	MK-DDC-S462B2201	3" ASA 300					
	MK-DDC-S467B2201	TTMA 3"	25	AISI 316			
	MK-DDC-S468B2201	TTMA 4"					
	MK-DDC-S436B4401	DN80 PN10/16					
	MK-DDC-S437B4401	DN80 PN25/40					
	MK-DDC-S461B4401	3" ASA 150	6	PEEK			
	MK-DDC-S462B4401	3" ASA 300					
	MK-DDC-S467B4401	TTMA 3"					
	MK-DDC-S468B4401	TTMA 4"					
MK-DDC-S436A9901	DN80 PN10/16						
MK-DDC-S461A9901	3" ASA 150						
	MK-DDC-P400A2201	-	-	composite	FPM/ FKM	-	-
	MK-DDC-P400A1101			aluminium			
	MK-DDC-P400A4401			AISI 316			
Repair kit set of O-rings	MK-DDC-O-S4-01	-	-	FPM/FKM	-	-	-
Repair kit flat seal	MK-1110-09	3" BSP	-	PUR	-	-	0.006
	MK-1110-06			PTFE			0.007
Set of spare parts	MK-DDC-S-S4-11	-	10	aluminium	-	-	-
	MK-DDC-S-S4-22		16	brass			
	MK-DDC-S-S4-44		25	AISI 316			

Tank unit - size 4" (Ø 164)

picture	code	connection	work. press. [bar]	material	seal		weight [kg]
					O-ring	thread	
	MK-DDC-T516A1101B	4" BSP	10	aluminium	FPM/ FKM	PUR	-
	MK-DDC-T516D2201B	4" BSP	16	bronze			
	MK-DDC-T516B4401A	4" BSP	25	AISI 316		PTFE	
	MK-DDC-T539D1101	DN100 PN10/16	10	aluminium	FPM/ FKM	-	-
	MK-DDC-T563D1101	4" ASA 150					
	MK-DDC-T568D1101	TTMA 4"					
	MK-DDC-T539D2201	DN100 PN10/16					
	MK-DDC-T540D2201	DN100 PN25/40	16	bronze			
	MK-DDC-T563D2201	4" ASA 150					
	MK-DDC-T564D2201	4" ASA 300					
	MK-DDC-T568D2201	TTMA 4"					
	MK-DDC-T539B4401	DN100 PN10/16	25	AISI 316			
	MK-DDC-T540B4401	DN100 PN25/40					
	MK-DDC-T563B4401	4" ASA 150					
	MK-DDC-T564B4401	4" ASA 300					
MK-DDC-T568B4401	TTMA 4"						

INDUSTRIAL FITTINGS - couplings

Dry disconnect couplings - DDC

Tank unit - size 4" (Ø 164)

picture	code	connection	work. press. [bar]	material	seal		weight [kg]
					O-ring	thread	
	MK-DDC-C500E2202	-	-	composite	NBR	-	-
	MK-DDC-C500B1101			aluminium	FPM/FKM		
	MK-DDC-C500C4401			AISI 316	FPM/FKM		
Repair kit set of O-rings	MK-DDC-O-T5-01	-	-	FPM/FKM	-	-	-
Repair kit flat seal	MK-1295-09	4" BSP	-	PUR	-	-	0.010
	MK-1295-06			PTFE	-	-	0.009
Set of spare parts	MK-DDC-S-T5-11	-	10	aluminium	-	-	-
	MK-DDC-S-T5-22		16	brass			
	MK-DDC-S-T5-44		25	AISI 316			



Hose unit - size 4" (Ø 164)

picture	code	connection	work. press. [bar]	material	seal		weight [kg]
					O-ring	thread	
	MK-DDC-S516B1101B	4" BSP	10	aluminium	FPM/FKM	PUR	-
	MK-DDC-S516B2201B	4" BSP	16	bronze			
	MK-DDC-S516B4401A	4" BSP	25	AISI 316			
	MK-DDC-S539B1101	DN100 PN10/16	10	aluminium	FPM/FKM	-	-
	MK-DDC-S563B1101	4" ASA 150					
	MK-DDC-S568B1101	TTMA 4"					
	MK-DDC-S539B2201	DN100 PN10/16	16	bronze			
	MK-DDC-S540B2201	DN100 PN25/40					
	MK-DDC-S563B2201	4" ASA 150					
	MK-DDC-S564B2201	4" ASA 300	25	AISI 316			
	MK-DDC-S568B2201	TTMA 4"					
	MK-DDC-S539B4401	DN100 PN10/16					
	MK-DDC-S540B4401	DN100 PN25/40	25	AISI 316			
	MK-DDC-S563B4401	4" ASA 150					
	MK-DDC-S564B4401	4" ASA 300					
MK-DDC-S568B4401	TTMA 4"						
	MK-DDC-P500B2201	-	-	composite	FPM/FKM	-	-
	MK-DDC-P500B1101			aluminium			
	MK-DDC-P500B4401			AISI 316			
Repair kit set of O-rings	MK-DDC-O-S5-01	-	-	FPM/FKM	-	-	-
Repair kit flat seal	MK-1295-09	4" BSP	-	PUR	-	-	0.010
	MK-1295-06			PTFE	-	-	0.009
Set of spare parts	MK-DDC-S-S5-11	-	10	aluminium	-	-	-
	MK-DDC-S-S5-22		16	brass			
	MK-DDC-S-S5-44		25	AISI 316			



INDUSTRIAL FITTINGS - couplings

Dry disconnect couplings - DDC

Tank unit - size 6" (Ø 238)

picture	code	connection	work. press. [bar]	material	seal		weight [kg]
					O-ring	thread	
	MK-DDC-T6110B1101B	6" BSP	10	aluminium	FPM/ FKM	PUR	-
	MK-DDC-T6110B4401A	6" BSP	16	AISI 316		PTFE	
	MK-DDC-T645B1101	DN150 PN10/16	10	aluminium	FPM/ FKM	-	-
	MK-DDC-T6100B1101	6" ASA 150					
	MK-DDC-T645B4401	DN150 PN10/16	16	AISI 316			
	MK-DDC-T6100B4401	6" ASA 150					
	MK-DDC-C600A1101	-	-	aluminium	FPM/ FKM	-	-
Repair kit set of O-rings	MK-DDC-O-T6-01	-	-	FPM/FKM	-	-	-
Repair kit flat seal	MK-1963-09	6" BSP	-	PUR	-	-	0.016
	MK-1963-06			PTFE			
Set of spare parts	MK-DDC-S-T6-11	-	10	aluminium	-	-	-
	MK-DDC-S-T6-44		16	AISI 316			



Hose unit - size 6" (Ø 238)

picture	code	connection	work. press. [bar]	material	seal		weight [kg]
					O-ring	thread	
	MK-DDC-S6110B1101B	6" BSP	10	aluminium	FPM/ FKM	PUR	-
	MK-DDC-S6110B4401A	6" BSP	16	AISI 316		PTFE	
	MK-DDC-S645B1101	DN150 PN10/16	10	aluminium	FPM/ FKM	-	-
	MK-DDC-S6100B1101	6" ASA 150					
	MK-DDC-S645B4401	DN150 PN10/16	16	AISI 316			
	MK-DDC-S6100B4401	6" ASA 150					
	MK-DDC-P600A1101	-	-	aluminium	FPM/ FKM	-	-
Repair kit set of O-rings	MK-DDC-O-S6-01	-	-	FPM/FKM	-	-	-
Repair kit flat seal	MK-1963-09	6" BSP	-	PUR	-	-	0.016
	MK-1963-06			PTFE			
Set of spare parts	MK-DDC-S-S6-11	-	10	aluminium	-	-	-
	MK-DDC-S-S6-44		16	AISI 316			



INDUSTRIAL FITTINGS - couplings

Dry disconnect couplings - DDC

Tank unit - size 8" (Ø 272)

picture	code	connection	work. press. [bar]	material	seal		weight [kg]
					O-ring	thread	
	MK-DDC-T8102A1101	DN200 PN10	10	aluminium	FPM/ FKM	-	-
	MK-DDC-T8103A1101	DN200 PN16					
	MK-DDC-T8105A1101	8" ASA 150					
	MK-DDC-T8102A4401	DN200 PN10	16	AISI 316			
	MK-DDC-T8103A4401	DN200 PN16					
	MK-DDC-T8105A4401	8" ASA 150					
	MK-DDC-C800A1101	-	-	aluminium	FPM/ FKM	-	-
Repair kit set of O-rings	MK-DDC-O-T8-01	-	-	FPM/FKM	-	-	-
Set of spare parts	MK-DDC-S-T8-11	-	10	aluminium	-	-	-
	MK-DDC-S-T8-44		16	AISI 316			

Hose unit - size 8" (Ø 272)

picture	code	connection	work. press. [bar]	material	seal		weight [kg]
					O-ring	thread	
	MK-DDC-S8102A1101	DN200 PN10	10	aluminium	FPM/ FKM	-	-
	MK-DDC-S8103A1101	DN200 PN16					
	MK-DDC-S8105A1101	8" ASA 150					
	MK-DDC-S8102A4401	DN200 PN10	16	AISI 316			
	MK-DDC-S8103A4401	DN200 PN16					
	MK-DDC-S8105A4401	8" ASA 150					
	MK-DDC-P800A1101	-	-	aluminium	FPM/ FKM	-	-
Repair kit set of O-rings	MK-DDC-O-S8-01	-	-	FPM/FKM	-	-	-
Set of spare parts	MK-DDC-S-S8-11	-	10	aluminium	-	-	-
	MK-DDC-S-S8-44		16	AISI 316			

INDUSTRIAL FITTINGS - couplings

Dry disconnect couplings - DGC

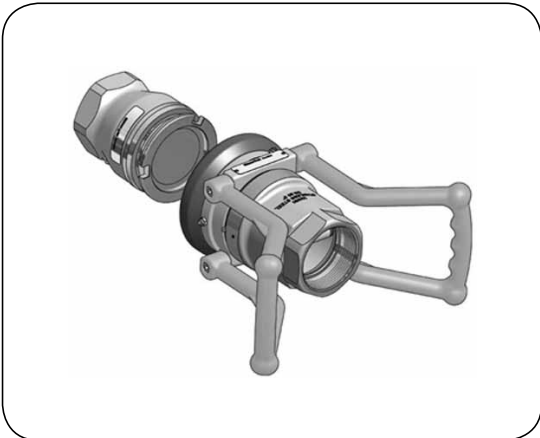

Material: AISI 316
(bronze / brass version available)

Seals: O-ring: FPM (Viton), NBR
Flat seal: PTFE
(other materials on request)

Connections: BSP, NPT thread; DIN, ASA flanges
(ACME, Whitworth thread available).

Working temp.: From -20°C up to +80°C

The acceptable working temperature ranges from -50°C up to +200°C, but as it depends on the medium, confirm the working temperature of each application with Technical Department of TUBES INTERNATIONAL®.

Operation

A hose unit (coupler) and a tank unit (adapter) of DGC type (Dry Gas Coupling) are both equipped with piston valves which can be opened only after the coupling is connected and closed before it is disconnected. It prevents spillage. The head of the hose unit is rotary (360°). To allow medium flow both units must be coupled by rotating the head of the hose unit about 100° clockwise. During rotation the coupling locks, the valve of the hose unit slides towards the tank unit and the medium starts to flow. To stop the flow, turn the head of the hose unit anticlockwise so the valves close and the coupling disconnects.

Application

Dry disconnect couplings of DGC type (Dry Gas Couplings) are designed for gas transfer, LPG in particular. They are widely used in road, rail, water and air transport, in petrochemical, chemical and pharmaceutical industry. They meet all requirements for safe, reliable and environment friendly transfer of hazardous, toxic or valuable fluids.

Standards

Meet the requirements of ATEX, TDT, ADR, RID, IMDG, Pressure Equipment Directive 97/23/EC (PED).

Flow rate, maximum spillage at disconnection

size [inch]	1	2	3	4
DN [mm]	25	50	80	100
plug diameter [mm]	56	71	119	164
max. spillage [ml]	0.2	0.3	0.7	1.6

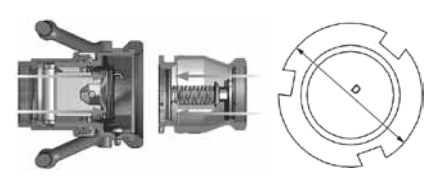

Pressure drop vs. flow rate

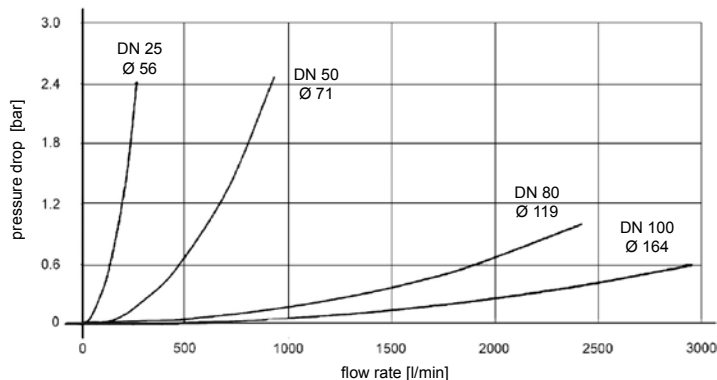



Test parameters:

Medium: n-paraffin
Temperature: +20°C
Density: 0.75 kg/dm³
Viscosity: 1.75 mm²/s
Stanag 3756. annex E



INDUSTRIAL FITTINGS - couplings

Dry disconnect couplings - DGC

Tank unit - size 1" (Ø 56)

picture	code	connection	work. press. [bar]	material	seal		weight [kg]
					O-ring	thread	
	MK-DGC-L101A4401A	3/4" BSP	25	AISI 316	FPM/ FKM	PTFE	0.70
	MK-DGC-L102A4401	3/4" NPT				-	0.80
	MK-DGC-L103A4401A	1" BSP				PTFE	0.70
	MK-DGC-L104A4401	1" NPT				-	0.80
	MK-DGC-L105A4401A	1.1/4" BSP				PTFE	0.70
	MK-DGC-L106A4401	1.1/4" NPT				-	0.80
	MK-DGC-L150A4401	3/4" ASA 300	25	AISI 316	FPM/ FKM	-	1.30
	MK-DGC-L124A4401	DN25 PN25/40					1.40
	MK-DGC-L152A4401	1" ASA 300					1.50
	MK-DGC-L126A4401	DN32 PN25/40					
	MK-DGC-L154A4401	1.1/4" ASA 300					
	MK-DGC-CG100A2201	-	-	composite	FPM/ FKM	-	-
Repair kit set of O-rings	MK-DGC-O-L1-01	-	-	FPM/FKM	-	-	-
Repair kit flat seal	MK-1498-06	3/4"	-	PTFE	-	-	0.001
	MK-1220-06	1"	-				0.002
Set of spare parts	MK-DGC-S-L1-44	-	25	AISI 316	-	-	-



Hose unit - size 1" (Ø 56)

picture	code	connection	work. press. [bar]	material	seal		weight [kg]
					O-ring	thread	
	MK-DGC-M101A4401A	3/4" BSP	25	AISI 316	FPM/ FKM	PTFE	0.70
	MK-DGC-M102A4401	3/4" NPT				-	0.80
	MK-DGC-M103A4401A	1" BSP				PTFE	0.70
	MK-DGC-M104A4401	1" NPT				-	0.80
	MK-DGC-M105A4401A	1.1/4" BSP				PTFE	0.70
	MK-DGC-M106A4401	1.1/4" NPT				-	0.80
	MK-DGC-M150A4401	3/4" ASA 300	25	AISI 316	FPM/ FKM	-	
	MK-DGC-M124A4401	DN25 PN25/40					
	MK-DGC-M152A4401	1" ASA 300					
	MK-DGC-M126A4401	DN32 PN25/40					
	MK-DGC-M154A4401	1.1/4" ASA 300					
	MK-DGC-V100A2201	-	-	composite	FPM/ FKM	-	-
Repair kit set of O-rings	MK-DGC-O-M1-01	-	-	FPM/FKM	-	-	-
Repair kit flat seal	MK-1498-06	3/4"	-	PTFE	-	-	0.001
	MK-1220-06	1"	-				0.002
Set of spare parts	MK-DGC-S-M1-44	-	25	AISI 316	-	-	-



INDUSTRIAL FITTINGS - couplings

Dry disconnect couplings - DGC

Tank unit - size 2" (Ø 71)

picture	code	connection	work. press. [bar]	material	seal		weight [kg]
					O-ring	thread	
	MK-DGC-L207A4401A	1.1/2" BSP	25	AISI 316	FPM/ FKM	PTFE	1.50
	MK-DGC-L208A4401	1.1/2" NPT				-	1.60
	MK-DGC-L210A4401A	2" BSP				PTFE	1.20
	MK-DGC-L211A4401	2" NPT				-	1.30
	MK-DGC-L228A4401	DN40 PN25/40	25	AISI 316	FPM/ FKM	-	2.80
	MK-DGC-L256A4401	1.1/2" ASA 300					3.20
	MK-DGC-L231A4401	DN50 PN25/40					3.50
	MK-DGC-L258A4401	2" ASA 300					
	MK-DGC-C200D1300	-	-	PVC/NBR	-	-	-
Repair kit set of O-rings	MK-DGC-O-L2-01	-	-	FPM/FKM	-	-	-
Repair kit flat seal	MK-1196-06	1.1/2	-	PTFE	-	-	0.003
	MK-1052-06	2					0.004
Set of spare parts	MK-DGC-S-L2-44	-	25	AISI 316	-	-	-



Hose unit - size 2" (Ø 71)

picture	code	connection	work. press. [bar]	material	seal		weight [kg]
					O-ring	thread	
	MK-DGC-M207A4401A	1.1/2" BSP	25	AISI 316	FPM/ FKM	PTFE	3.10
	MK-DGC-M208A4401	1.1/2" NPT				-	3.20
	MK-DGC-M210A4401A	2" BSP				PTFE	2.90
	MK-DGC-M211A4401	2" NPT				-	3.00
	MK-DGC-M228A4401	DN40 PN25/40	25	AISI 316	FPM/ FKM	-	5.30
	MK-DGC-M256A4401	1.1/2" ASA 300					5.70
	MK-DGC-M231A4401	DN50 PN25/40					-
	MK-DGC-M258A4401	2" ASA 300					6.10
	MK-DGC-V200A2201	-	-	composite	FPM/ FKM	-	-
Repair kit set of O-rings	MK-DGC-O-M2-01	-	-	FPM/FKM	-	-	-
Repair kit flat seal	MK-1196-06	1.1/2	-	PTFE	-	-	0.003
	MK-1052-06	2					0.004
Set of spare parts	MK-DGC-S-M2-44	-	25	AISI 316	-	-	-



INDUSTRIAL FITTINGS - couplings

Dry disconnect couplings - DGC

Tank unit - size 3" (Ø 119)

picture	code	connection	work. press. [bar]	material	seal		weight [kg]
					O-ring	thread	
	MK-DGC-L414B4401A	3" BSP	25	AISI 316	FPM/FKM	PTFE	3.00
	MK-DGC-L415B4401	3" NPT				-	
	MK-DGC-L434B4401	DN65 PN25/40	25	AISI 316	FPM/FKM	-	5.00
	MK-DGC-L460B4401	2.1/2" ASA 300					
	MK-DGC-L437B4401	DN80 PN25/40					5.50
	MK-DGC-L462B4401	3" ASA 300					
	MK-DGC-C400E2202	-	-	composite	NBR	-	-
Repair kit set of O-rings	MK-DGC-O-L4-01	-	-	FPM/FKM	-	-	-
Repair kit flat seal	MK-1110-06	3"	-	PTFE	-	-	0.006
Set of spare parts	MK-DGC-S-L4-44	-	25	AISI 316	-	-	-



Hose unit- size 3" (Ø 119)

picture	code	connection	work. press. [bar]	material	seal		weight [kg]
					O-ring	thread	
	MK-DGC-M412B4401A	2.1/2" BSP	25	AISI 316	FPM/FKM	PTFE	8.80
	MK-DGC-M413B4401	2.1/2" NPT				-	9.10
	MK-DGC-M414B4401A	3" BSP				PTFE	8.10
	MK-DGC-M415B4401	3" NPT				-	8.40
	MK-DGC-M434B4401	DN65 PN25/40	25	AISI 316	FPM/FKM	-	12.60
	MK-DGC-M460B4401	2 1/2" ASA 300					13.30
	MK-DGC-M437B4401	DN80 PN25/40					13.20
	MK-DGC-M462B4401	3" ASA 300					15.10
	MK-DGC-V400A2201	-	-	composite	FPM/FKM	-	-
Repair kit set of O-rings	MK-DGC-O-M4-01	-	-	FPM/FKM	-	-	-
Repair kit flat seal	MK-1181-06	2.1/2"	-	PTFE	-	-	0.006
	MK-1110-06	3					0.007
Set of spare parts	MK-DGC-S-M4-44	-	25	AISI 316	-	-	-



INDUSTRIAL FITTINGS - couplings

Dry disconnect couplings - DGC

Tank unit - size 4" (Ø 164)

picture	code	connection	work. press. [bar]	material	seal		weight [kg]
					O-ring	thread	
	MK-DGC-L516B4401A	4" BSP	25	AISI 316	FPM/ FKM	PTFE	6.10
	MK-DGC-L517B4401	4" NPT				-	6.30
	MK-DGC-L540B4401	DN100 PN25/40	25	AISI 316	FPM/ FKM	-	9.30
	MK-DGC-L564B4401	4" ASA 300					
	MK-DGC-C500E2202	-	-	composite	NBR	-	-
Repair kit set of O-rings	MK-DGC-O-L5-01	-	-	FPM/FKM	-	-	-
Repair kit flat seal	MK-1295-06	4"	-	PTFE	-	-	0.009
Set of spare parts	MK-DGC-S-L5-44	-	25	AISI 316	-	-	-

Hose unit - size 4" (Ø 164)

picture	code	connection	work. press. [bar]	material	seal		weight [kg]
					O-ring	thread	
	MK-DGC-M516B4401A	4" BSP	25	AISI 316	FPM/ FKM	PTFE	15.70
	MK-DGC-M517B4401	4" NPT				-	16.00
	MK-DGC-M540B4401	DN100 PN25/40	25	AISI 316	FPM/ FKM	-	20.80
	MK-DGC-M564B4401	4" ASA 300					24.30
	MK-DGC-P500B2201	-	-	composite	FPM/ FKM	-	-
Repair kit set of O-rings	MK-DGC-O-M5-01	-	-	FPM/FKM	-	-	-
Repair kit flat seal	MK-1295-06	4"	-	PTFE	-	-	0.009
Set of spare parts	MK-DGC-S-M5-44	-	25	AISI 316	-	-	-

INDUSTRIAL FITTINGS - couplings

Dry disconnect couplings - DAC

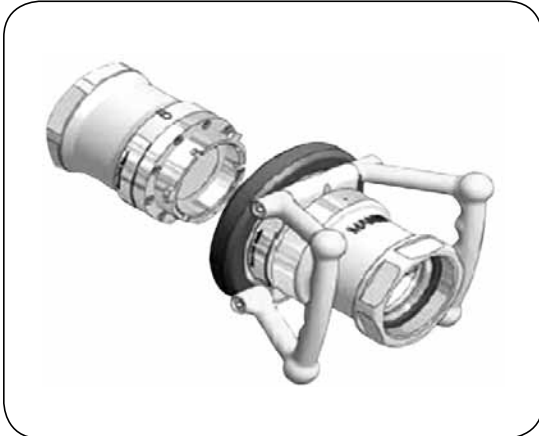

Material: Aluminium (AISI 316 version available).
Seals: O-ring: FPM (Viton), NBR, for low working temperature, FQM
Flat seal: PTFE.
(other materials on request)
Connections: BSP, NPT thread,
DIN, ASA, TW and TTMA flanges.
Working temp.: From -20°C up to +60°C

A wider working temperature range is acceptable, but as it depends on the medium, confirm the working temperature of each application with Technical Department of TUBES INTERNATIONAL®.

Operation

A hose unit (coupler) and a tank unit (adapter) of DAC type (Dry Aviation Coupling) are both equipped with piston valves which can be opened only after the coupling is connected and closed before it is disconnected. It prevents spillage. The head of the hose unit is rotary (360°). To allow fluid flow both units must be coupled by rotating the head of the hose unit about 100° clockwise. During rotation the coupling locks, the valve of the hose unit slides towards the tank unit and the medium starts to flow. To stop fluid flow, turn the head of the hose unit anticlockwise so the valves close and the coupling disconnects.

Application

DAC couplings are designed for jet fuel transfer. They are widely used in road and air transport. They meet all requirements for safe, reliable and environment friendly transfer of hazardous, toxic or valuable products. Not suitable for underwing refuelling. It can be mounted on a flexible hose assembly on the side of a tank truck or storage container.

Standards

Meet the requirements of ATEX, ADR, TDT, Pressure Equipment Directive 97/23/EC (PED). Compatible with aviation couplings according to NATO STANAG 3105. Manufactured according to ISO 45, MS24484, British Aerospace Spec. 2C14.

Spillage

Once DAC 2.1/2" coupling is disconnected, the spillage amounts to 1.1 ml.

Pressure drop vs. flow rate

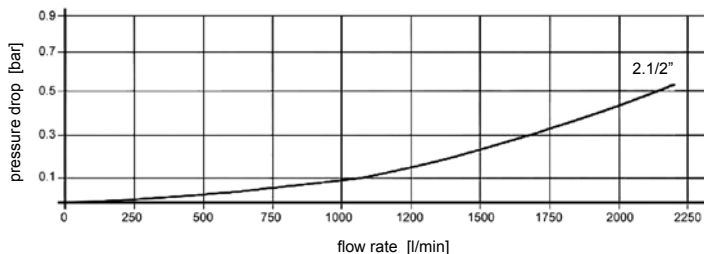



Test parameters:

Medium: n-paraffin
Temperature: +20°C
Density: 0.75 kg/dm³
Viscosity: 1.75 mm²/s
Stanag 3756. annex E



INDUSTRIAL FITTINGS - couplings

Dry disconnect couplings - DAC

Tank unit- size 2.1/2"

picture	code	connection	work. press. [bar]	material	seal		weight [kg]
					O-ring	thread	
	MK-DAC-G312A1401B	2.1/2" BSP	10	aluminium	FPM/ FKM	PUR	2.30
	MK-DAC-G314A1401B	3" BSP					
	MK-DAC-G313A1401	2.1/2" NPT					
	MK-DAC-G315A1401	3" NPT					
	MK-DAC-G333D1401	DN65 PN10/16	10	aluminium	FPM/ FKM	-	2.80
	MK-DAC-G336D1401	DN80 PN10/16					3.00
	MK-DAC-G359D1401	2.1/2" ASA 150					2.70
	MK-DAC-G361D1401	3" ASA 150					2.90
	MK-DAC-G367D1401	3" TTMA					2.40
	MK-DAC-G368D1401	4" TTMA					2.60
	MK-DAC-G365D1401	TW 1 (DIN 28459)					2.50
	MK-DAC-G366D1401	TW 3 (DIN 28459)					2.90
	MK-DAC-K300A1101	-	-	aluminium	FPM/ FKM	-	0.50
	MK-DAC-K300A2201			composite			0.20
Repair kit set of O-rings	MK-DAC-O-G3-01	-	-	FPM/FKM	-	-	--
Repair kit flat seal	MK-1181-09	2.1/2" BSP	-	-	PUR	-	0.005
Set of spare parts	MK-DAC-S-G3-14	2.1/2"	10	aluminium	-	-	--

Hose unit - size 2.1/2"

picture	code	connection	work. press. [bar]	material	seal		weight [kg]
					O-ring	thread	
	MK-DAC-F312B1101B	2.1/2" BSP	10	aluminium	FPM/ FKM	PUR	3.40
	MK-DAC-F314B1101B	3" BSP					3.50
	MK-DAC-F313B1101	2.1/2" NPT					3.40
	MK-DAC-F315B1101	3" NPT					3.50
	MK-DAC-F333B1101	DN65 PN10/16	10	aluminium	FPM/ FKM	-	
	MK-DAC-F336B1101	DN80 PN10/16					
	MK-DAC-F359B1101	2.1/2" ASA 150					
	MK-DAC-F361B1101	3" ASA 150					
	MK-DAC-F367B1101	3" TTMA					
	MK-DAC-F368B1101	4" TTMA					
	MK-DAC-F365B1101	TW 1 (DIN 28459)					
	MK-DAC-F366B1101	TW 3 (DIN 28459)					
	MK-DAC-I300A1101	-	-	aluminium	FPM/ FKM	-	0.40
	MK-DAC-I300A2201			composite			0.20
Repair kit set of O-rings	MK-DAC-O-F3-01	-	-	FPM/FKM	-	-	-
Repair kit flat seal	MK-1181-09	2.1/2" BSP	-	-	PUR	-	0.005
Set of spare parts	MK-DAC-S-F3-11	2.1/2"	10	aluminium	-	-	--