

INDUSTRIAL FITTINGS - couplings

Lever couplings LAUX 42

LAUX 42 couplings due to their simple, robust and reliable construction are widely used in:

- chemical and paper industry as reloading couplings,
- in waste water transport trucks,
- for transfer and reloading of loose materials (grain, flour, animal feed, granules, cement, minerals),
- for temporary water and air installations in such industries as construction, mining, agriculture, etc.
- for pressure and vacuum pumps,
- irrigation systems.

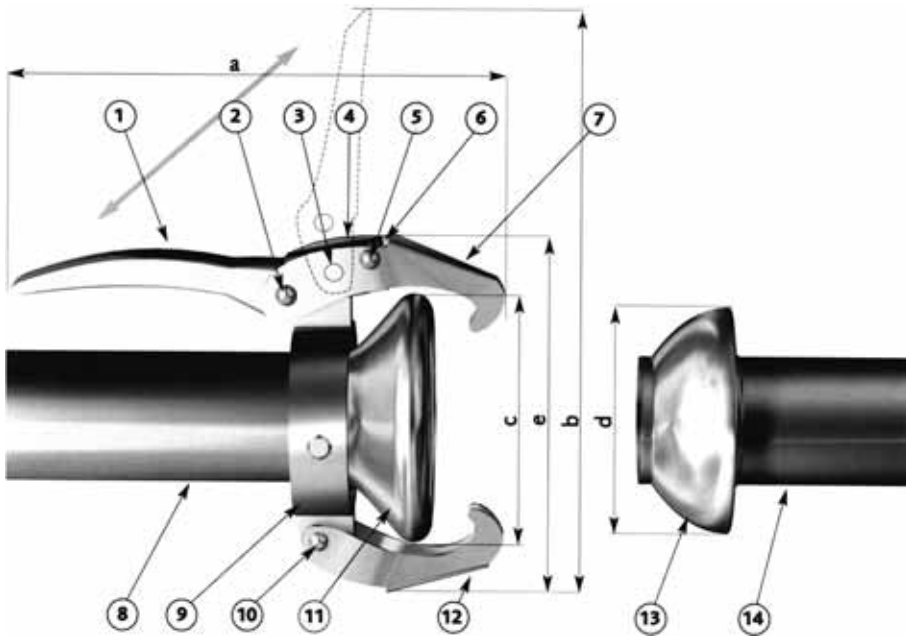

- 1 - lever
- 2 - rivet for over hook
- 3 - rivet for under hook
- 4 - lock
- 5 - rivet for lock
- 6 - spring for lock
- 7 - over hook
- 8 - pipe
- 9 - ring
- 10 - rivet for under hook
- 11 - female part
- 12 - under hook
- 13 - male part
- 14 - pipe

Max. working pressure

- for liquids 12.5 bar
- for air 8 bar
- vacuum-tight

Seals:

- EPDM from -50°C up to +120°C
- NBR from -40°C up to +100°C
- Viton from -30°C up to +250°C
- silicone from -70°C up to +250°C

EPDM seal is used as a standard.

| size | a | b | c | d | e |
|------|-----|-----|-----|-----|-----|
| 38 | 186 | 230 | 72 | 67 | 105 |
| 48 | 240 | 295 | 104 | 100 | 155 |
| 60 | 240 | 305 | 115 | 109 | 165 |
| 76 | 285 | 360 | 135 | 129 | 205 |
| 102 | 285 | 380 | 162 | 158 | 235 |
| 133 | 380 | 490 | 193 | 179 | 295 |
| 152 | 380 | 530 | 218 | 200 | 315 |
| 204* | 380 | 550 | 286 | 278 | 380 |

* the female coupling has 3 levers

| KKG | code (EPDM) | code (NBR) | code (Viton) | code (silicone) | coupling size | d | D | t |
|----------------|-------------|------------|--------------|-----------------|---------------|-----|-----|----|
| | TF-1626407 | TF-1626605 | TF-1626928 | - | 38 | 54 | 70 | 8 |
| | TF-1626415 | TF-1626613 | TF-1626936 | TF-1626993 | 48 | 72 | 100 | 14 |
| | TF-1626423 | TF-1626621 | TF-1626944 | - | 60 | 82 | 112 | 15 |
| | TF-1626431 | TF-1626639 | TF-1626951 | TF-1626995 | 76 | 100 | 130 | 15 |
| | TF-1626449 | TF-1626647 | TF-1626969 | TF-1626997 | 102 | 126 | 162 | 18 |
| | TF-1626456 | TF-1626654 | TF-1626977 | - | 133 | 145 | 189 | 22 |
| | TF-1626464 | TF-1626662 | TF-1626985 | - | 152 | 171 | 215 | 22 |
| | - | TF-1626672 | - | - | 204 | 245 | 275 | 15 |

INDUSTRIAL FITTINGS - couplings

Lever couplings LAUX 42

Plug with male thread



KVG

| connection size x thread | galvanized steel | aluminium | stainless steel |
|--------------------------|------------------|------------|-----------------|
| 38 x 1.1/4 | TF-1621000 | - | TF-1631403 |
| 38 x 1.1/2 | TF-1621002 | - | TF-1631405 |
| 48 x 1.1/2 | TF-1621010 | TF-1632409 | TF-1631407 |
| 48 x 2 | TF-1621028 | TF-1632418 | TF-1631415 |
| 76 x 2 | TF-1621051 | TF-1632436 | TF-1631423 |
| 76 x 2.1/2 | TF-1621069 | TF-1632445 | TF-1631431 |
| 76 x 3 | TF-1621077 | TF-1632454 | TF-1631449 |
| 102 x 3 | TF-1621081 | TF-1632461 | TF-1631456 |
| 102 x 4 | TF-1621085 | TF-1632463 | TF-1631458 |
| 133 x 5 | TF-1621093 | - | TF-1631461 |
| 152 x 4 | - | TF-1632476 | - |
| 152 x 6 | TF-1621101 | - | TF-1631470 |

Plug with hose tail



KVS

| connection size x hose tail size | galvanized steel | aluminium | stainless steel |
|----------------------------------|------------------|------------|-----------------|
| 38 x 32 | - | - | TF-1631700 |
| 38 x 38 | TF-1621606 | - | TF-1631702 |
| 48 x 38 | TF-1621614 | TF-1632809 | TF-1631704 |
| 48 x 48 | TF-1621622 | TF-1632818 | TF-1631712 |
| 48 x 61 | - | - | TF-1631720 |
| 76 x 48 | TF-1621655 | TF-1632845 | TF-1631738 |
| 76 x 61 | TF-1621663 | TF-1632854 | TF-1631746 |
| 76 x 74 | TF-1621670 | TF-1632861 | - |
| 76 x 76 | TF-1621671 | TF-1632863 | TF-1631753 |
| 102 x 74 | TF-1621672 | TF-1632864 | - |
| 102 x 76 | TF-1621673 | TF-1632865 | - |
| 102 x 90 | TF-1621675 | TF-1632867 | - |
| 102 x 100 | TF-1621689 | TF-1632872 | TF-1631761 |
| 133 x 125 | TF-1621697 | TF-1632881 | TF-1631769 |
| 152 x 148 | TF-1621705 | TF-1632890 | TF-1631777 |
| 204 x 198 | TF-1621715 | - | TF-1631785 |

Socket with male thread

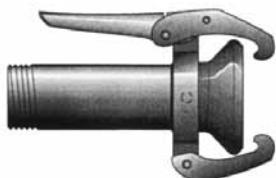

KMG

| connection size x thread | galvanized steel | aluminium | stainless steel |
|--------------------------|------------------|------------|-----------------|
| 38 x 1.1/4 | TF-1621194 | - | TF-1631502 |
| 38 x 1.1/2 | TF-1621200 | - | TF-1631504 |
| 48 x 1.1/2 | TF-1621218 | TF-1632509 | TF-1631506 |
| 48 x 2 | TF-1621226 | TF-1632518 | TF-1631514 |
| 76 x 2 | TF-1621259 | TF-1632536 | TF-1631522 |
| 76 x 2.1/2 | TF-1621267 | TF-1632545 | TF-1631530 |
| 76 x 3 | TF-1621275 | TF-1632554 | TF-1631548 |
| 102 x 3 | TF-1621279 | TF-1632561 | TF-1631554 |
| 102 x 4 | TF-1621283 | TF-1632563 | TF-1631556 |
| 133 x 5 | TF-1621291 | - | TF-1631562 |
| 152 x 4 | - | TF-1632576 | - |
| 152 x 6 | TF-1621309 | - | TF-1631570 |

Socket with hose tail

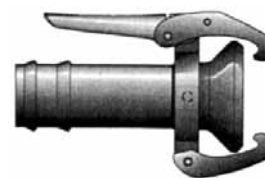

KMS

| connection size x hose tail size | galvanized steel | aluminium | stainless steel |
|----------------------------------|------------------|------------|-----------------|
| 38 x 32 | - | - | TF-1631800 |
| 38 x 38 | TF-1621804 | - | TF-1631801 |
| 48 x 38 | TF-1621812 | TF-1632909 | TF-1631803 |
| 48 x 48 | TF-1621820 | TF-1632918 | TF-1631811 |
| 48 x 61 | - | - | TF-1631829 |
| 76 x 48 | TF-1621853 | TF-1632945 | TF-1631837 |
| 76 x 61 | TF-1621861 | TF-1632954 | TF-1631845 |
| 76 x 74 | TF-1621878 | TF-1632961 | - |
| 76 x 76 | TF-1621879 | TF-1632963 | TF-1631852 |
| 102 x 74 | TF-1621880 | TF-1632964 | - |
| 102 x 76 | TF-1621881 | TF-1632965 | - |
| 102 x 90 | TF-1621883 | TF-1632967 | - |
| 102 x 100 | TF-1621887 | TF-1632972 | TF-1631860 |
| 133 x 125 | TF-1621895 | TF-1632981 | TF-1631868 |
| 152 x 148 | TF-1621903 | TF-1632990 | TF-1631876 |
| 204 x 198 | TF-1621915 | - | TF-1631884 |

INDUSTRIAL FITTINGS - couplings

Lever couplings LAUX 42

| Plug with welding end | | | |
|---|----------------------|------------|--------------------|
|  | | | |
| KKV | | | |
| connection size x welding end | galvanized steel* | aluminium | stainless steel |
| 38 x 38 | TF-1621408 | - | TF-1631603 |
| 38 x 42 | TF-1621410 | - | - |
| 48 x 50 | TF-1621416 | TF-1632609 | TF-1631605 |
| 48 x 60 | TF-1621418 | - | - |
| 76 x 60 | TF-1621429 | - | TF-1631611 |
| 76 x 76 | TF-1621432 | TF-1632627 | TF-1631613 |
| 76 x 89 | TF-1621434 | - | TF-1631617 |
| 102 x 102 | TF-1621440 | TF-1632636 | TF-1631621 |
| 102 x 114 | TF-1621442 | - | TF-1631623 |
| 133 x 127 | - | TF-1632645 | TF-1631629 |
| 133 x 133 | TF-1621457 | - | - |
| 133 x 139 | TF-1621459 | - | - |
| 152 x 152 | TF-1621465 | TF-1632654 | TF-1631637 |
| 152 x 168 | TF-1621467 | - | - |
| 204 x 204 | TF-1621475 | - | TF-1631639 |
| 204 x 219 | TF-1621477 | - | - |

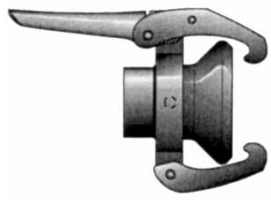
| Socket with welding end | | | |
|--|----------------------|------------|--------------------|
|  | | | |
| KKM | | | |
| connection size x welding end | galvanized steel* | aluminium | stainless steel |
| 38 x 38 | TF-1621507 | - | TF-1631668 |
| 38 x 42 | TF-1621509 | - | - |
| 48 x 50 | TF-1621515 | TF-1632709 | TF-1631670 |
| 48 x 60 | TF-1621517 | - | - |
| 76 x 60 | TF-1621528 | - | TF-1631685 |
| 76 x 76 | TF-1621531 | TF-1632727 | TF-1631688 |
| 76 x 84 | - | - | TF-1631690 |
| 76 x 89 | TF-1621533 | - | TF-1631692 |
| 102 x 102 | TF-1621549 | TF-1632736 | TF-1631696 |
| 102 x 114 | TF-1621551 | - | TF-1631697 |
| 133 x 127 | - | TF-1632745 | TF-1631698 |
| 133 x 133 | TF-1621556 | - | - |
| 133 x 139 | TF-1621558 | - | - |
| 152 x 152 | TF-1621564 | TF-1632754 | TF-1631699 |
| 152 x 168 | TF-1621566 | - | - |
| 204 x 204 | TF-1621575 | - | TF-1631701 |
| 204 x 219 | TF-1621577 | - | - |

* - non-galvanized version also available.

| Plug end cap | | | |
|---|---------------------|------------|--------------------|
|  | | | |
| KXM | | | |
| size [mm] | galvanized steel | aluminium | stainless steel |
| 38 | - | - | TF-1630977 |
| 48 | TF-1622513 | TF-1633309 | TF-1630979 |
| 76 | TF-1622539 | TF-1633327 | TF-1630987 |
| 102 | TF-1622547 | TF-1633336 | TF-1630995 |
| 133 | TF-1622554 | TF-1633345 | TF-1630997 |
| 152 | TF-1622562 | TF-1633354 | TF-1630999 |
| 204 | TF-1622575 | - | TF-1631000 |

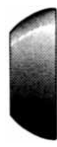
| Socket end cap | | | |
|---|---------------------|------------|--------------------|
|  | | | |
| KXV | | | |
| size [mm] | galvanized steel | aluminium | stainless steel |
| 38 | TF-1622406 | - | TF-1630902 |
| 48 | TF-1622414 | TF-1633209 | TF-1630904 |
| 76 | TF-1622430 | TF-1633227 | TF-1630912 |
| 102 | TF-1622448 | TF-1633236 | TF-1630920 |
| 133 | TF-1622455 | TF-1633245 | TF-1630928 |
| 152 | TF-1622463 | TF-1633254 | TF-1630936 |
| 204 | TF-1622475 | - | TF-1630944 |