

# HIGH PRESSURE - DIN 2353 connectors

## Codes of connectors in the catalogue

Connectors are marked with special codes in our catalogue - they should be used when placing an order.

Code example:

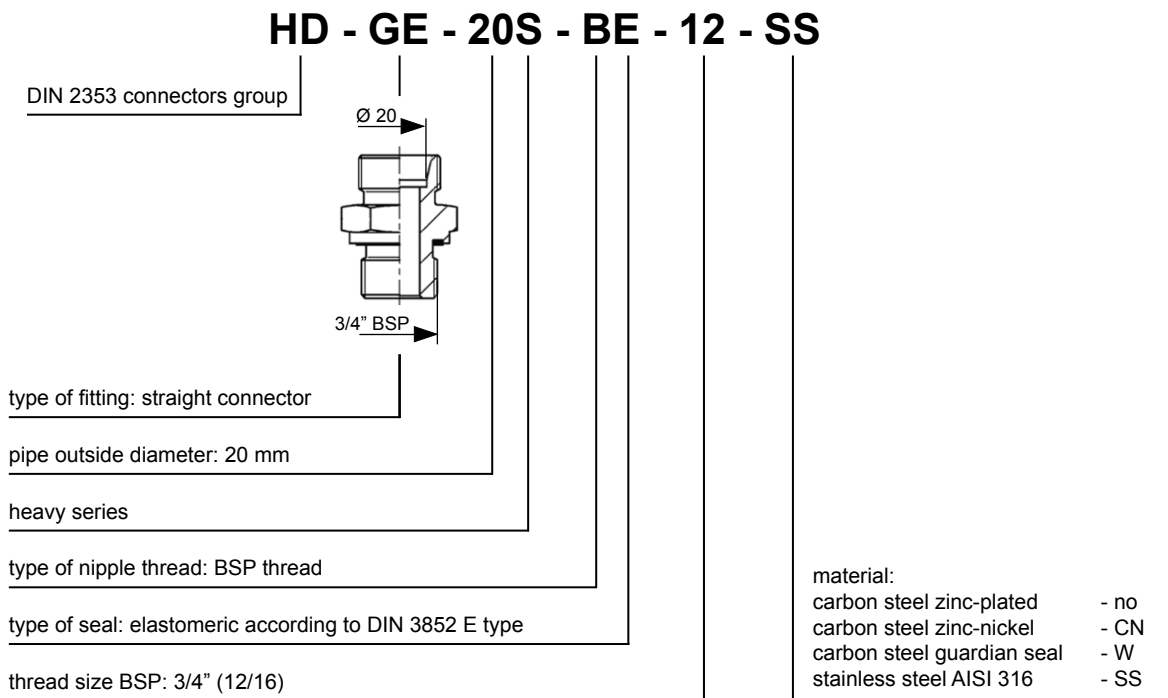
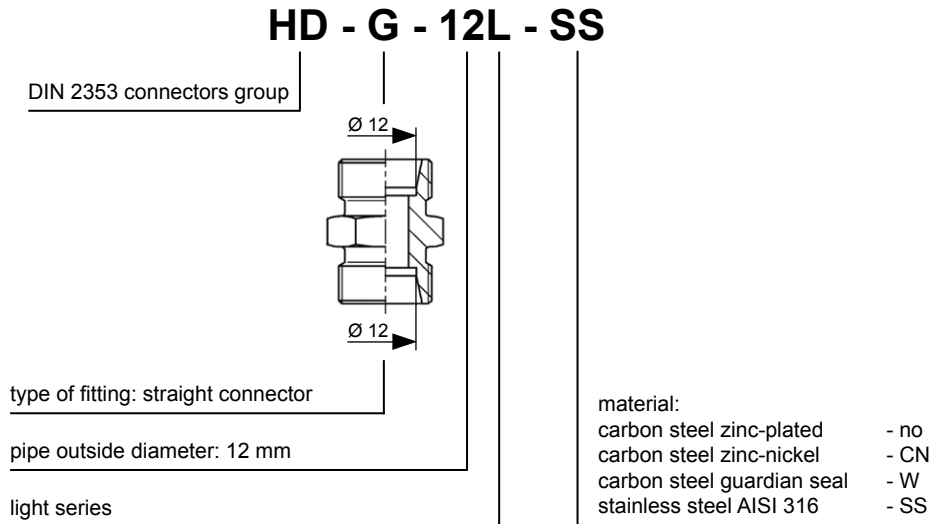

# HIGH PRESSURE - DIN 2353 connectors

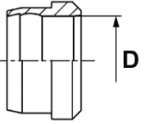
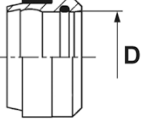
description	series	press. [bar]	code (galvanized steel)	code (AISI 316)	code (galvanized steel)	code (AISI 316)	D [mm]	
Cutting ring      <b>D</b>  <b>DU</b>	LL	100	HD-D-04LL	HD-D-04LL-SS	-	-	4	
			HD-D-06LL	HD-D-06LL-SS	-	-	6	
			HD-D-08LL	HD-D-08LL-SS	-	-	8	
	L	315	HD-D-06	HD-D-06-SS	HD-DU-06L	HD-DU-06L-SS	6	
			HD-D-08	HD-D-08-SS	HD-DU-08L	HD-DU-08L-SS	8	
			HD-D-10	HD-D-10-SS	HD-DU-10L	HD-DU-10L-SS	10	
			HD-D-12	HD-D-12-SS	HD-DU-12L	HD-DU-12L-SS	12	
			HD-D-15	HD-D-15-SS	HD-DU-15L	HD-DU-15L-SS	15	
			HD-D-18	HD-D-18-SS	HD-DU-18L	HD-DU-18L-SS	18	
		160	HD-D-22	HD-D-22-SS	HD-DU-22L	HD-DU-22L-SS	22	
			HD-D-28	HD-D-28-SS	HD-DU-28L	HD-DU-28L-SS	28	
			HD-D-35	HD-D-35-SS	HD-DU-35L	HD-DU-35L-SS	35	
	S	630	HD-D-06	HD-D-06-SS	HD-DU-06S	HD-DU-06S-SS	6	
			HD-D-08	HD-D-08-SS	HD-DU-08S	HD-DU-08S-SS	8	
			HD-D-10	HD-D-10-SS	HD-DU-10S	HD-DU-10S-SS	10	
			HD-D-12	HD-D-12-SS	HD-DU-12S	HD-DU-12S-SS	12	
			HD-D-14	HD-D-14-SS	HD-DU-14S	HD-DU-14S-SS	14	
			HD-D-16	HD-D-16-SS	HD-DU-16S	HD-DU-16S-SS	16	
		400	HD-D-20	HD-D-20-SS	HD-DU-20S	HD-DU-20S-SS	20	
			HD-D-25	HD-D-25-SS	HD-DU-25S	HD-DU-25S-SS	25	
			HD-D-30	HD-D-30-SS	HD-DU-30S	HD-DU-30S-SS	30	
			315	HD-D-38	HD-D-38-SS	HD-DU-38S	HD-DU-38S-SS	38

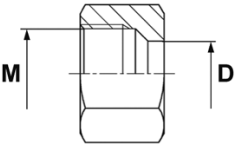
description	series	press. [bar]	code (galvanized steel)	code (AISI 316)	D [mm]	M [mm]
Nut    <b>M</b>	LL	100	HD-M-04LL	HD-M-04LL-SS	4	8x1
			HD-M-06LL	HD-M-06LL-SS	6	10x1
			HD-M-08LL	HD-M-08LL-SS	8	12x1
	L	315	HD-M-06L	HD-M-06L-SS	6	12x1.5
			HD-M-08L	HD-M-08L-SS	8	14x1.5
			HD-M-10L	HD-M-10L-SS	10	16x1.5
			HD-M-12L	HD-M-12L-SS	12	18x1.5
			HD-M-15L	HD-M-15L-SS	15	22x1.5
			HD-M-18L	HD-M-18L-SS	18	26x1.5
		160	HD-M-22L	HD-M-22L-SS	22	30x2
			HD-M-28L	HD-M-28L-SS	28	36x2
			HD-M-35L	HD-M-35L-SS	35	45x2
	S	630	HD-M-06S	HD-M-06S-SS	6	14x1.5
			HD-M-08S	HD-M-08S-SS	8	16x1.5
			HD-M-10S	HD-M-10S-SS	10	18x1.5
			HD-M-12S	HD-M-12S-SS	12	20x1.5
			HD-M-14S	HD-M-14S-SS	14	22x1.5
			HD-M-16S	HD-M-16S-SS	16	24x1.5
		400	HD-M-20S	HD-M-20S-SS	20	30x2
			HD-M-25S	HD-M-25S-SS	25	36x2
			HD-M-30S	HD-M-30S-SS	30	42x2
315			HD-M-38S	HD-M-38S-SS	38	52x2

# HIGH PRESSURE - DIN 2353 connectors

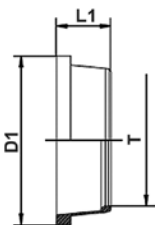
description	series	press. [bar]	code (FPM rubber)	T [mm]	D1 [mm]	L1 [mm]
Profiled seal, material: Viton  	L/S	630	HD-UDV-06LS	6	9	7.5
			HD-UDV-08LS	8	11	7.5
			HD-UDV-10LS	10	13.5	7.5
			HD-UDV-12LS	12	15.5	7
	L	400	HD-UDV-15L	15	19	7
			HD-UDV-18L	18	23	8
		250	HD-UDV-22L	22	26.5	8
			HD-UDV-28L	28	32.5	8
			HD-UDV-35L	35	41.5	8
			HD-UDV-42L	42	48.5	8
	S	630	HD-UDV-14S	14	19	7
			HD-UDV-16S	16	21	7.5
		420	HD-UDV-20S	20	26	9.5
			HD-UDV-25S	25	31.5	9
	315	HD-UDV-30S	30	37.5	8	
		HD-UDV-38S	38	46	8	

**UDV**

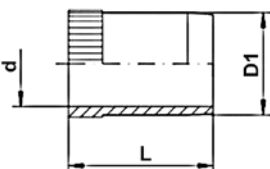
description	pipe I.D. [mm]	code (brass)	code (AISI 316)	d [mm]	D [mm]	L [mm]
Reinforcing insert for thin-walled pipes DIN 2353  	4	HD-VS-04	HD-VS-04-SS	2.5	3.8	17
	5	HD-VS-05	HD-VS-05-SS	3.5	4.8	17
	6	HD-VS-06	HD-VS-06-SS	4.5	5.8	17 / 14*
	7	-	HD-VS-07-SS	5.5	6.8	17
	8	HD-VS-08	HD-VS-08-SS	6.5	7.8	17 / 15.5*
	9	HD-VS-09	HD-VS-09-SS	7.5	8.8	17
	10	HD-VS-10	HD-VS-10-SS	8.5	9.8	17 / 15.5*
	11	-	HD-VS-11-SS	9.5	10.8	17
	12	HD-VS-12	HD-VS-12-SS	10.5	11.8	17
	13	HD-VS-13	HD-VS-13-SS	11.5	12.8	18 / 17*
	14	-	HD-VS-14-SS	12	13.8	17
	15	HD-VS-15	HD-VS-15-SS	13	14.8	18
	16	HD-VS-16	HD-VS-16-SS	14	15.8	18
	17	-	HD-VS-17-SS	15	16.8	20
	18	HD-VS-18	HD-VS-18-SS	16	17.8	22 / 20*
	19	HD-VS-19	HD-VS-19-SS	17	18.8	20
	20	-	HD-VS-20-SS	18	19.8	20
	22	-	HD-VS-22-SS	20	21.8	24
	23	-	HD-VS-23-SS	21	22.8	24
	24	HD-VS-24	HD-VS-24-SS	22	23.8	20 / 23.5*
	25	HD-VS-25	HD-VS-25-SS	23	24.8	20 / 23.5*
	26	-	HD-VS-26-SS	24	25.8	23.5
	30	-	HD-VS-30-SS	27.8	29.8	26.5
	31	HD-VS-31	HD-VS-31-SS	28	30.8	23 / 26.5*
	32	-	HD-VS-32-SS	29.5	31.8	26.5
	33	-	HD-VS-33-SS	30	32.8	26.5
	38	HD-VS-38	HD-VS-38-SS	35	37.8	24 / 26.5*

**VS**

\*- L length is different for stainless steel

# HIGH PRESSURE - DIN 2353 connectors

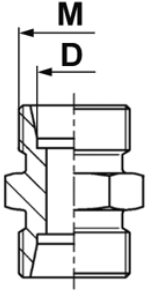
description	series	press. [bar]	code (galvanized steel)	code (AISI 316)	D [mm]	M [mm]	
Straight connector  	LL	100	HD-G-04LL	HD-G-04LL-SS	4	8x1	
			HD-G-06LL	HD-G-06LL-SS	6	10x1	
			HD-G-08LL	HD-G-08LL-SS	8	12x1	
	L	315	HD-G-06L	HD-G-06L-SS	6	12x1.5	
			HD-G-08L	HD-G-08L-SS	8	14x1.5	
			HD-G-10L	HD-G-10L-SS	10	16x1.5	
			HD-G-12L	HD-G-12L-SS	12	18x1.5	
			HD-G-15L	HD-G-15L-SS	15	22x1.5	
			HD-G-18L	HD-G-18L-SS	18	26x1.5	
		160	HD-G-22L	HD-G-22L-SS	22	30x2	
			HD-G-28L	HD-G-28L-SS	28	36x2	
			HD-G-35L	HD-G-35L-SS	35	45x2	
	S	630	HD-G-06S	HD-G-06S-SS	6	14x1.5	
			HD-G-08S	HD-G-08S-SS	8	16x1.5	
			HD-G-10S	HD-G-10S-SS	10	18x1.5	
			HD-G-12S	HD-G-12S-SS	12	20x1.5	
			HD-G-14S	HD-G-14S-SS	14	22x1.5	
			HD-G-16S	HD-G-16S-SS	16	24x1.5	
		400	HD-G-20S	HD-G-20S-SS	20	30x2	
			HD-G-25S	HD-G-25S-SS	25	36x2	
			HD-G-30S	HD-G-30S-SS	30	42x2	
			HD-G-38S	HD-G-38S-SS	38	52x2	

**G**

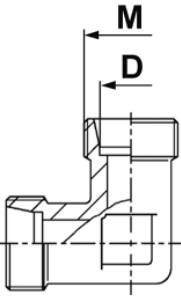
description	series	press. [bar]	code (galvanized steel)	code (AISI 316)	D [mm]	M [mm]
90° elbow connector  	LL	100	HD-W-04LL	HD-W-04LL-SS	4	8x1
			HD-W-06LL	HD-W-06LL-SS	6	10x1
			HD-W-08LL	HD-W-08LL-SS	8	12x1
	L	315	HD-W-06L	HD-W-06L-SS	6	12x1.5
			HD-W-08L	HD-W-08L-SS	8	14x1.5
			HD-W-10L	HD-W-10L-SS	10	16x1.5
			HD-W-12L	HD-W-12L-SS	12	18x1.5
			HD-W-15L	HD-W-15L-SS	15	22x1.5
			HD-W-18L	HD-W-18L-SS	18	26x1.5
		160	HD-W-22L	HD-W-22L-SS	22	30x2
			HD-W-28L	HD-W-28L-SS	28	36x2
			HD-W-35L	HD-W-35L-SS	35	45x2
	S	630	HD-W-06S	HD-W-06S-SS	6	14x1.5
			HD-W-08S	HD-W-08S-SS	8	16x1.5
			HD-W-10S	HD-W-10S-SS	10	18x1.5
			HD-W-12S	HD-W-12S-SS	12	20x1.5
			HD-W-14S	HD-W-14S-SS	14	22x1.5
			HD-W-16S	HD-W-16S-SS	16	24x1.5
		400	HD-W-20S	HD-W-20S-SS	20	30x2
			HD-W-25S	HD-W-25S-SS	25	36x2
			HD-W-30S	HD-W-30S-SS	30	42x2
			HD-W-38S	HD-W-38S-SS	38	52x2

**W**

## HIGH PRESSURE - DIN 2353 connectors

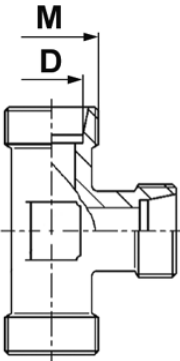
description	series	press. [bar]	code (galvanized steel)	code (AISI 316)	D [mm]	M [mm]
Tee connector  	L	315	HD-T-06L	HD-T-06L-SS	6	12x1.5
			HD-T-08L	HD-T-08L-SS	8	14x1.5
			HD-T-10L	HD-T-10L-SS	10	16x1.5
			HD-T-12L	HD-T-12L-SS	12	18x1.5
			HD-T-15L	HD-T-15L-SS	15	22x1.5
		HD-T-18L	HD-T-18L-SS	18	26x1.5	
		160	HD-T-22L	HD-T-22L-SS	22	30x2
			HD-T-28L	HD-T-28L-SS	28	36x2
			HD-T-35L	HD-T-35L-SS	35	45x2
			HD-T-42L	HD-T-42L-SS	42	52x2
	S		630	HD-T-06S	HD-T-06S-SS	6
		HD-T-08S		HD-T-08S-SS	8	16x1.5
		HD-T-10S		HD-T-10S-SS	10	18x1.5
		HD-T-12S		HD-T-12S-SS	12	20x1.5
		HD-T-14S		HD-T-14S-SS	14	22x1.5
		400	HD-T-16S	HD-T-16S-SS	16	24x1.5
			HD-T-20S	HD-T-20S-SS	20	30x2
			HD-T-25S	HD-T-25S-SS	25	36x2
			HD-T-30S	HD-T-30S-SS	30	42x2
			315	HD-T-38S	HD-T-38S-SS	38

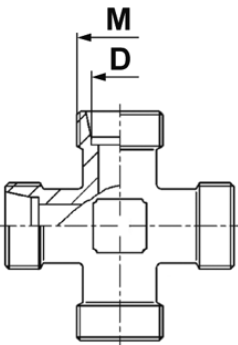
description	series	press. [bar]	code (galvanized steel)	code (AISI 316)	D [mm]	M [mm]
Cross connector  	L	315	HD-K-06L	HD-K-06L-SS	6	12x1.5
			HD-K-08L	HD-K-08L-SS	8	14x1.5
			HD-K-10L	HD-K-10L-SS	10	16x1.5
			HD-K-12L	HD-K-12L-SS	12	18x1.5
			HD-K-15L	HD-K-15L-SS	15	22x1.5
		HD-K-18L	HD-K-18L-SS	18	26x1.5	
		160	HD-K-22L	HD-K-22L-SS	22	30x2
			HD-K-28L	HD-K-28L-SS	28	36x2
			HD-K-35L	HD-K-35L-SS	35	45x2
			HD-K-42L	HD-K-42L-SS	42	52x2
	S		630	HD-K-06S	HD-K-06S-SS	6
		HD-K-08S		HD-K-08S-SS	8	16x1.5
		HD-K-10S		HD-K-10S-SS	10	18x1.5
		HD-K-12S		HD-K-12S-SS	12	20x1.5
		HD-K-14S		HD-K-14S-SS	14	22x1.5
		400	HD-K-16S	HD-K-16S-SS	16	24x1.5
			HD-K-20S	HD-K-20S-SS	20	30x2
			HD-K-25S	HD-K-25S-SS	25	36x2
			HD-K-30S	HD-K-30S-SS	30	42x2
			315	HD-K-38S	HD-K-38S-SS	38

# HIGH PRESSURE - DIN 2353 connectors

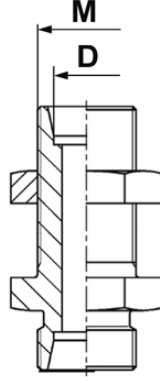
description	series	press. [bar]	code (galvanized steel)	code (AISI 316)	D [mm]	M [mm]
Straight bulkhead connector    <b>SV</b>	L	315	HD-SV-06L	HD-SV-06L-SS	6	12x1.5
			HD-SV-08L	HD-SV-08L-SS	8	14x1.5
			HD-SV-10L	HD-SV-10L-SS	10	16x1.5
			HD-SV-12L	HD-SV-12L-SS	12	18x1.5
			HD-SV-15L	HD-SV-15L-SS	15	22x1.5
			HD-SV-18L	HD-SV-18L-SS	18	26x1.5
		160	HD-SV-22L	HD-SV-22L-SS	22	30x2
			HD-SV-28L	HD-SV-28L-SS	28	36x2
			HD-SV-35L	HD-SV-35L-SS	35	45x2
			HD-SV-42L	HD-SV-42L-SS	42	52x2
	S	630	HD-SV-06S	HD-SV-06S-SS	6	14x1.5
			HD-SV-08S	HD-SV-08S-SS	8	16x1.5
			HD-SV-10S	HD-SV-10S-SS	10	18x1.5
			HD-SV-12S	HD-SV-12S-SS	12	20x1.5
			HD-SV-14S	HD-SV-14S-SS	14	22x1.5
		400	HD-SV-16S	HD-SV-16S-SS	16	24x1.5
			HD-SV-20S	HD-SV-20S-SS	20	30x2
			HD-SV-25S	HD-SV-25S-SS	25	36x2
			HD-SV-30S	HD-SV-30S-SS	30	42x2
			315	HD-SV-38S	HD-SV-38S-SS	38

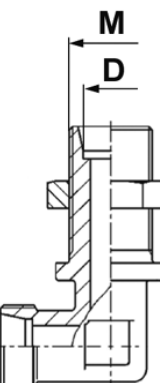
description	series	press. [bar]	code (galvanized steel)	code (AISI 316)	D [mm]	M [mm]
90° elbow bulkhead connector    <b>WSV</b>	L	315	HD-WSV-06L	HD-WSV-06L-SS	6	12x1.5
			HD-WSV-08L	HD-WSV-08L-SS	8	14x1.5
			HD-WSV-10L	HD-WSV-10L-SS	10	16x1.5
			HD-WSV-12L	HD-WSV-12L-SS	12	18x1.5
			HD-WSV-15L	HD-WSV-15L-SS	15	22x1.5
			HD-WSV-18L	HD-WSV-18L-SS	18	26x1.5
		160	HD-WSV-22L	HD-WSV-22L-SS	22	30x2
			HD-WSV-28L	HD-WSV-28L-SS	28	36x2
			HD-WSV-35L	HD-WSV-35L-SS	35	45x2
			HD-WSV-42L	HD-WSV-42L-SS	42	52x2
	S	630	HD-WSV-06S	HD-WSV-06S-SS	6	14x1.5
			HD-WSV-08S	HD-WSV-08S-SS	8	16x1.5
			HD-WSV-10S	HD-WSV-10S-SS	10	18x1.5
			HD-WSV-12S	HD-WSV-12S-SS	12	20x1.5
			HD-WSV-14S	HD-WSV-14S-SS	14	22x1.5
		400	HD-WSV-16S	HD-WSV-16S-SS	16	24x1.5
			HD-WSV-20S	HD-WSV-20S-SS	20	30x2
			HD-WSV-25S	HD-WSV-25S-SS	25	36x2
			HD-WSV-30S	HD-WSV-30S-SS	30	42x2
			315	HD-WSV-38S	HD-WSV-38S-SS	38

# HIGH PRESSURE - DIN 2353 connectors

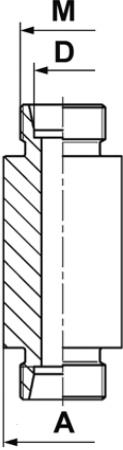
description	series	press. [bar]	code (black steel)	code (AISI 316)	D [mm]	M [mm]	A [mm]
Welding bulkhead connector 	L	315	HD-ESV-06L	HD-ESV-06L-SS	6	12x1.5	18
			HD-ESV-08L	HD-ESV-08L-SS	8	14x1.5	20
			HD-ESV-10L	HD-ESV-10L-SS	10	16x1.5	22
			HD-ESV-12L	HD-ESV-12L-SS	12	18x1.5	25
			HD-ESV-15L	HD-ESV-15L-SS	15	22x1.5	28
		HD-ESV-18L	HD-ESV-18L-SS	18	26x1.5	32	
		160	HD-ESV-22L	HD-ESV-22L-SS	22	30x2	36
			HD-ESV-28L	HD-ESV-28L-SS	28	36x2	40
			HD-ESV-35L	HD-ESV-35L-SS	35	45x2	50
			HD-ESV-42L	HD-ESV-42L-SS	42	52x2	60
	S		630	HD-ESV-06S	HD-ESV-06S-SS	6	14x1.5
		HD-ESV-08S		HD-ESV-08S-SS	8	16x1.5	22
		HD-ESV-10S		HD-ESV-10S-SS	10	18x1.5	25
		HD-ESV-12S		HD-ESV-12S-SS	12	20x1.5	28
		HD-ESV-14S		HD-ESV-14S-SS	14	22x1.5	30
		400	HD-ESV-16S	HD-ESV-16S-SS	16	24x1.5	35
			HD-ESV-20S	HD-ESV-20S-SS	20	30x2	38
			HD-ESV-25S	HD-ESV-25S-SS	25	36x2	45
			HD-ESV-30S	HD-ESV-30S-SS	30	42x2	50
			315	HD-ESV-38S	HD-ESV-38S-SS	38	52x2

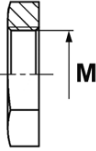
description	code (galvanized steel)	code (AISI 316)	M [mm]
Flat nut for bulkhead connectors 	HD-MP-06L	HD-MP-06L-SS	12x1.5
	HD-MP-08L-06S	HD-MP-08L-06S-SS	14x1.5
	HD-MP-10L-08S	HD-MP-10L-08S-SS	16x1.5
	HD-MP-12L-10S	HD-MP-12L-10S-SS	18x1.5
	HD-MP-12S	HD-MP-12S-SS	20x1.5
	HD-MP-15L-14S	HD-MP-15L-14S-SS	22x1.5
	HD-MP-16S	HD-MP-16S-SS	24x1.5
	HD-MP-18L	HD-MP-18L-SS	26x1.5
	HD-MP-22L-20S	HD-MP-22L-20S-SS	30x2
	HD-MP-28L-25S	HD-MP-28L-25S-SS	36x2
	HD-MP-30S	HD-MP-30S-SS	42x2
	HD-MP-35L	HD-MP-35L-SS	48x2
	HD-MP-42L-38S	HD-MP-42L-38S-SS	52x2

# HIGH PRESSURE - DIN 2353 connectors

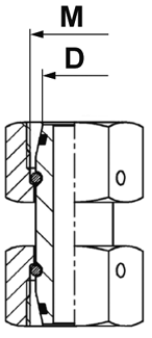
description	series	press. [bar]	code (galvanized steel)	code (AISI 316)	D [mm]	M [mm]
Adjustable straight connector, O-ring seal    <b>SNV</b>	L	315	HD-SNV-06L	HD-SNV-06L-SS	6	12x1.5
			HD-SNV-08L	HD-SNV-08L-SS	8	14x1.5
			HD-SNV-10L	HD-SNV-10L-SS	10	16x1.5
			HD-SNV-12L	HD-SNV-12L-SS	12	18x1.5
			HD-SNV-15L	HD-SNV-15L-SS	15	22x1.5
			HD-SNV-18L	HD-SNV-18L-SS	18	26x1.5
		160	HD-SNV-22L	HD-SNV-22L-SS	22	30x2
			HD-SNV-28L	HD-SNV-28L-SS	28	36x2
			HD-SNV-35L	HD-SNV-35L-SS	35	45x2
			HD-SNV-42L	HD-SNV-42L-SS	42	52x2
	S	630	HD-SNV-06S	HD-SNV-06S-SS	6	14x1.5
			HD-SNV-08S	HD-SNV-08S-SS	8	16x1.5
			HD-SNV-10S	HD-SNV-10S-SS	10	18x1.5
			HD-SNV-12S	HD-SNV-12S-SS	12	20x1.5
			HD-SNV-14S	HD-SNV-14S-SS	14	22x1.5
		400	HD-SNV-16S	HD-SNV-16S-SS	16	24x1.5
			HD-SNV-20S	HD-SNV-20S-SS	20	30x2
			HD-SNV-25S	HD-SNV-25S-SS	25	36x2
			HD-SNV-30S	HD-SNV-30S-SS	30	42x2
			315	HD-SNV-38S	HD-SNV-38S-SS	38

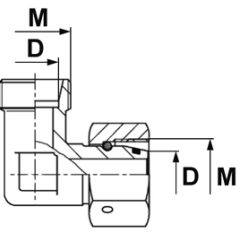
description	series	press. [bar]	code (galvanized steel)	code (AISI 316)	D [mm]	M [mm]
Adjustable 90° elbow connector, O-ring seal    <b>EVWO</b>	L	315	HD-EVWO-06L	HD-EVWO-06L-SS	6	12x1.5
			HD-EVWO-08L	HD-EVWO-08L-SS	8	14x1.5
			HD-EVWO-10L	HD-EVWO-10L-SS	10	16x1.5
			HD-EVWO-12L	HD-EVWO-12L-SS	12	18x1.5
			HD-EVWO-15L	HD-EVWO-15L-SS	15	22x1.5
			HD-EVWO-18L	HD-EVWO-18L-SS	18	26x1.5
		160	HD-EVWO-22L	HD-EVWO-22L-SS	22	30x2
			HD-EVWO-28L	HD-EVWO-28L-SS	28	36x2
			HD-EVWO-35L	HD-EVWO-35L-SS	35	45x2
			HD-EVWO-42L	HD-EVWO-42L-SS	42	52x2
	S	630	HD-EVWO-06S	HD-EVWO-06S-SS	6	14x1.5
			HD-EVWO-08S	HD-EVWO-08S-SS	8	16x1.5
			HD-EVWO-10S	HD-EVWO-10S-SS	10	18x1.5
			HD-EVWO-12S	HD-EVWO-12S-SS	12	20x1.5
			HD-EVWO-14S	HD-EVWO-14S-SS	14	22x1.5
		400	HD-EVWO-16S	HD-EVWO-16S-SS	16	24x1.5
			HD-EVWO-20S	HD-EVWO-20S-SS	20	30x2
			HD-EVWO-25S	HD-EVWO-25S-SS	25	36x2
			HD-EVWO-30S	HD-EVWO-30S-SS	30	42x2
			315	HD-EVWO-38S	HD-EVWO-38S-SS	38

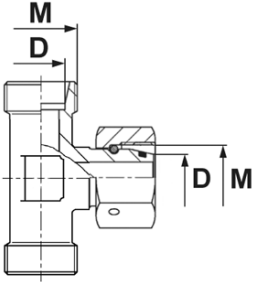

# HIGH PRESSURE - DIN 2353 connectors

description	series	press. [bar]	code (galvanized steel)	code (AISI 316)	D [mm]	M [mm]
Adjustable tee connector, O-ring seal    <b>EVTO</b>	L	315	HD-EVTO-06L	HD-EVTO-06L-SS	6	12x1.5
			HD-EVTO-08L	HD-EVTO-08L-SS	8	14x1.5
			HD-EVTO-10L	HD-EVTO-10L-SS	10	16x1.5
			HD-EVTO-12L	HD-EVTO-12L-SS	12	18x1.5
			HD-EVTO-15L	HD-EVTO-15L-SS	15	22x1.5
			HD-EVTO-18L	HD-EVTO-18L-SS	18	26x1.5
		160	HD-EVTO-22L	HD-EVTO-22L-SS	22	30x2
			HD-EVTO-28L	HD-EVTO-28L-SS	28	36x2
			HD-EVTO-35L	HD-EVTO-35L-SS	35	45x2
			HD-EVTO-42L	HD-EVTO-42L-SS	42	52x2
	S	630	HD-EVTO-06S	HD-EVTO-06S-SS	6	14x1.5
			HD-EVTO-08S	HD-EVTO-08S-SS	8	16x1.5
			HD-EVTO-10S	HD-EVTO-10S-SS	10	18x1.5
			HD-EVTO-12S	HD-EVTO-12S-SS	12	20x1.5
			HD-EVTO-14S	HD-EVTO-14S-SS	14	22x1.5
		400	HD-EVTO-16S	HD-EVTO-16S-SS	16	24x1.5
			HD-EVTO-20S	HD-EVTO-20S-SS	20	30x2
			HD-EVTO-25S	HD-EVTO-25S-SS	25	36x2
			HD-EVTO-30S	HD-EVTO-30S-SS	30	42x2
			HD-EVTO-38S	HD-EVTO-38S-SS	38	52x2

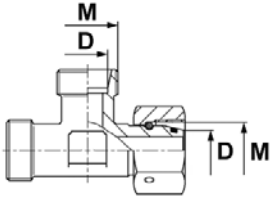
description	series	press. [bar]	code (galvanized steel)	code (AISI 316)	D [mm]	M [mm]
Asymmetric adjustable tee connector, O-ring seal    <b>EVLO</b>	L	315	HD-EVLO-06L	HD-EVLO-06L-SS	6	12x1.5
			HD-EVLO-08L	HD-EVLO-08L-SS	8	14x1.5
			HD-EVLO-10L	HD-EVLO-10L-SS	10	16x1.5
			HD-EVLO-12L	HD-EVLO-12L-SS	12	18x1.5
			HD-EVLO-15L	HD-EVLO-15L-SS	15	22x1.5
			HD-EVLO-18L	HD-EVLO-18L-SS	18	26x1.5
		160	HD-EVLO-22L	HD-EVLO-22L-SS	22	30x2
			HD-EVLO-28L	HD-EVLO-28L-SS	28	36x2
			HD-EVLO-35L	HD-EVLO-35L-SS	35	45x2
			HD-EVLO-42L	HD-EVLO-42L-SS	42	52x2
	S	630	HD-EVLO-06S	HD-EVLO-06S-SS	6	14x1.5
			HD-EVLO-08S	HD-EVLO-08S-SS	8	16x1.5
			HD-EVLO-10S	HD-EVLO-10S-SS	10	18x1.5
			HD-EVLO-12S	HD-EVLO-12S-SS	12	20x1.5
			HD-EVLO-14S	HD-EVLO-14S-SS	14	22x1.5
		400	HD-EVLO-16S	HD-EVLO-16S-SS	16	24x1.5
			HD-EVLO-20S	HD-EVLO-20S-SS	20	30x2
			HD-EVLO-25S	HD-EVLO-25S-SS	25	36x2
			HD-EVLO-30S	HD-EVLO-30S-SS	30	42x2
			HD-EVLO-38S	HD-EVLO-38S-SS	38	52x2

# HIGH PRESSURE - DIN 2353 connectors

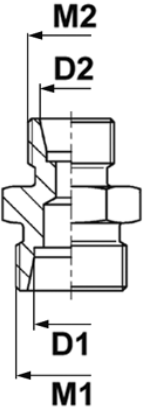
description	series	press. [bar]	code (galvanized steel)	code (AISI 316)	D1 [mm]	M1 [mm]	D2 [mm]	M2 [mm]
Reducing connector  	L	315	HD-GR-08-06L	HD-GR-08-06L-SS	8	14x1.5	6	12x1.5
			HD-GR-10-06L	HD-GR-10-06L-SS	10	16x1.5	6	12x1.5
			HD-GR-10-08L	HD-GR-10-08L-SS	10	16x1.5	8	14x1.5
			HD-GR-12-06L	HD-GR-12-06L-SS	12	18x1.5	6	12x1.5
			HD-GR-12-08L	HD-GR-12-08L-SS	12	18x1.5	8	14x1.5
			HD-GR-12-10L	HD-GR-12-10L-SS	12	18x1.5	10	16x1.5
			HD-GR-15-10L	HD-GR-15-10L-SS	15	22x1.5	10	16x1.5
			HD-GR-15-12L	HD-GR-15-12L-SS	15	22x1.5	12	18x1.5
			HD-GR-18-10L	HD-GR-18-10L-SS	18	26x1.5	10	16x1.5
		HD-GR-18-12L	HD-GR-18-12L-SS	18	26x1.5	12	18x1.5	
		HD-GR-18-15L	HD-GR-18-15L-SS	18	26x1.5	15	22x1.5	
		160	HD-GR-22-12L	HD-GR-22-12L-SS	22	30x2	12	18x1.5
			HD-GR-22-15L	HD-GR-22-15L-SS	22	30x2	15	22x1.5
			HD-GR-22-18L	HD-GR-22-18L-SS	22	30x2	18	26x1.5
			HD-GR-28-18L	HD-GR-28-18L-SS	28	36x2	18	26x1.5
			HD-GR-28-22L	HD-GR-28-22L-SS	28	36x2	22	30x2
			HD-GR-35-22L	HD-GR-35-22L-SS	35	45x2	22	30x2
		S	630	HD-GR-35-28L	HD-GR-35-28L-SS	35	45x2	28
	HD-GR-08-06S			HD-GR-08-06S-SS	8	16x1.5	6	14x1.5
	HD-GR-10-06S			HD-GR-10-06S-SS	10	18x1.5	6	14x1.5
	HD-GR-10-08S			HD-GR-10-08S-SS	10	18x1.5	8	16x1.5
	HD-GR-12-06S			HD-GR-12-06S-SS	12	20x1.5	6	14x1.5
	HD-GR-12-08S			HD-GR-12-08S-SS	12	20x1.5	8	16x1.5
	HD-GR-12-10S			HD-GR-12-10S-SS	12	20x1.5	10	18x1.5
	HD-GR-14-10S			HD-GR-14-10S-SS	14	22x1.5	10	18x1.5
	HD-GR-14-12S			HD-GR-14-12S-SS	14	22x1.5	12	20x1.5
	400		HD-GR-16-12S	HD-GR-16-12S-SS	16	24x1.5	12	20x1.5
			HD-GR-16-14S	HD-GR-16-14S-SS	16	24x1.5	14	22x1.5
			HD-GR-20-10S	HD-GR-20-10S-SS	20	30x2	10	18x1.5
			HD-GR-20-12S	HD-GR-20-12S-SS	20	30x2	12	20x1.5
			HD-GR-20-16S	HD-GR-20-16S-SS	20	30x2	16	24x1.5
			HD-GR-25-16S	HD-GR-25-16S-SS	25	36x2	16	24x1.5
			HD-GR-25-20S	HD-GR-25-20S-SS	25	36x2	20	30x2
			HD-GR-30-20S	HD-GR-30-20S-SS	30	42x2	20	30x2
			HD-GR-30-25S	HD-GR-30-25S-SS	30	42x2	25	36x2
315	HD-GR-38-30S	HD-GR-38-30S-SS	38	52x2	38	42x2		

**GR**

# HIGH PRESSURE - DIN 2353 connectors

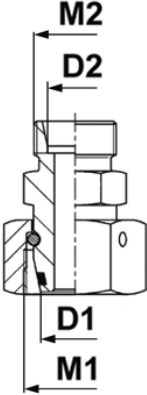
description	series	press. [bar]	code (galvanized steel)	code (AISI 316)	D1 [mm]	M1 [mm]	D2 [mm]	M2 [mm]
Reducing connector  	L	315	HD-KORO-08-06L	HD-KORO-08-06L-SS	8	14x1.5	6	12x1.5
			HD-KORO-10-06L	HD-KORO-10-06L-SS	10	16x1.5	6	12x1.5
			HD-KORO-12-06L	HD-KORO-12-06L-SS	12	18x1.5	6	12x1.5
			HD-KORO-15-06L	HD-KORO-15-06L-SS	15	22x1.5	6	12x1.5
			HD-KORO-18-06L	HD-KORO-18-06L-SS	18	26x1.5	6	12x1.5
		160	HD-KORO-22-06L	HD-KORO-22-06L-SS	22	30x2	6	12x1.5
			HD-KORO-28-06L	HD-KORO-28-06L-SS	28	36x2	6	12x1.5
			HD-KORO-35-06L	HD-KORO-35-06L-SS	35	45x2	6	12x1.5
			HD-KORO-42-06L	HD-KORO-42-06L-SS	42	52x2	6	12x1.5
		315	HD-KORO-10-08L	HD-KORO-10-08L-SS	10	16x1.5	8	14x1.5
			HD-KORO-12-08L	HD-KORO-12-08L-SS	12	18x1.5	8	14x1.5
			HD-KORO-15-08L	HD-KORO-15-08L-SS	15	22x1.5	8	14x1.5
		160	HD-KORO-18-08L	HD-KORO-18-08L-SS	18	26x1.5	8	14x1.5
			HD-KORO-22-08L	HD-KORO-22-08L-SS	22	30x2	8	14x1.5
			HD-KORO-28-08L	HD-KORO-28-08L-SS	28	36x2	8	14x1.5
			HD-KORO-35-08L	HD-KORO-35-08L-SS	35	45x2	8	14x1.5
		315	HD-KORO-42-08L	HD-KORO-42-08L-SS	42	52x2	8	14x1.5
			HD-KORO-12-10L	HD-KORO-12-10L-SS	12	18x1.5	10	16x1.5
			HD-KORO-15-10L	HD-KORO-15-10L-SS	15	22x1.5	10	16x1.5
		160	HD-KORO-18-10L	HD-KORO-18-10L-SS	18	26x1.5	10	16x1.5
			HD-KORO-22-10L	HD-KORO-22-10L-SS	22	30x2	10	16x1.5
			HD-KORO-28-10L	HD-KORO-28-10L-SS	28	36x2	10	16x1.5
			HD-KORO-35-10L	HD-KORO-35-10L-SS	35	45x2	10	16x1.5
		315	HD-KORO-42-10L	HD-KORO-42-10L-SS	42	52x2	10	16x1.5
			HD-KORO-15-12L	HD-KORO-15-12L-SS	15	22x1.5	12	18x1.5
			HD-KORO-18-12L	HD-KORO-18-12L-SS	18	26x1.5	12	18x1.5
		160	HD-KORO-22-12L	HD-KORO-22-12L-SS	22	30x2	12	18x1.5
			HD-KORO-28-12L	HD-KORO-28-12L-SS	28	36x2	12	18x1.5
			HD-KORO-35-12L	HD-KORO-35-12L-SS	35	45x2	12	18x1.5
			HD-KORO-42-12L	HD-KORO-42-12L-SS	42	52x2	12	18x1.5
		315	HD-KORO-18-15L	HD-KORO-18-15L-SS	18	26x1.5	15	22x1.5
		160	HD-KORO-22-15L	HD-KORO-22-15L-SS	22	30x2	15	22x1.5
			HD-KORO-28-15L	HD-KORO-28-15L-SS	28	36x2	15	22x1.5
			HD-KORO-35-15L	HD-KORO-35-15L-SS	35	45x2	15	22x1.5
			HD-KORO-42-15L	HD-KORO-42-15L-SS	42	52x2	15	22x1.5
			HD-KORO-22-18L	HD-KORO-22-18L-SS	22	30x2	18	26x1.5
			HD-KORO-28-18L	HD-KORO-28-18L-SS	28	36x2	18	26x1.5
			HD-KORO-35-18L	HD-KORO-35-18L-SS	35	45x2	18	26x1.5
			HD-KORO-42-18L	HD-KORO-42-18L-SS	42	52x2	18	26x1.5
			HD-KORO-28-22L	HD-KORO-28-22L-SS	28	36x2	22	30x2
			HD-KORO-35-22L	HD-KORO-35-22L-SS	35	45x2	22	30x2
			HD-KORO-42-22L	HD-KORO-42-22L-SS	42	52x2	22	30x2
			HD-KORO-35-28L	HD-KORO-35-28L-SS	35	45x2	28	36x2
			HD-KORO-42-28L	HD-KORO-42-28L-SS	42	52x2	28	36x2
		HD-KORO-42-35L	HD-KORO-42-35L-SS	42	52x2	35	45x2	

**KORO-L**

# HIGH PRESSURE - DIN 2353 connectors

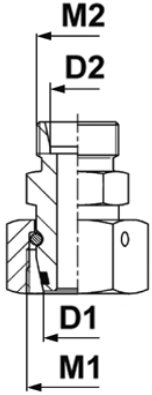
description	series	press. [bar]	code (galvanized steel)	code (AISI 316)	D1 [mm]	M1 [mm]	D2 [mm]	M2 [mm]
 <p style="text-align: center;"><b>KORO-S</b></p>	S	630	HD-KORO-08-06S	HD-KORO-08-06S-SS	8	16x1.5	6	14x1.5
			HD-KORO-10-06S	HD-KORO-10-06S-SS	10	18x1.5	6	14x1.5
			HD-KORO-12-06S	HD-KORO-12-06S-SS	12	20x1.5	6	14x1.5
			HD-KORO-14-06S	HD-KORO-14-06S-SS	14	22x1.5	6	14x1.5
		400	HD-KORO-16-06S	HD-KORO-16-06S-SS	16	24x1.5	6	14x1.5
			HD-KORO-20-06S	HD-KORO-20-06S-SS	20	30x2	6	14x1.5
			HD-KORO-25-06S	HD-KORO-25-06S-SS	25	36x2	6	14x1.5
		315	HD-KORO-30-06S	HD-KORO-30-06S-SS	30	42x2	6	14x1.5
			HD-KORO-38-06S	HD-KORO-38-06S-SS	38	52x2	6	14x1.5
		630	HD-KORO-10-08S	HD-KORO-10-08S-SS	10	18x1.5	8	16x1.5
			HD-KORO-12-08S	HD-KORO-12-08S-SS	12	20x1.5	8	16x1.5
			HD-KORO-14-08S	HD-KORO-14-08S-SS	14	22x1.5	8	16x1.5
		400	HD-KORO-16-08S	HD-KORO-16-08S-SS	16	24x1.5	8	16x1.5
			HD-KORO-20-08S	HD-KORO-20-08S-SS	20	30x2	8	16x1.5
			HD-KORO-25-08S	HD-KORO-25-08S-SS	25	36x2	8	16x1.5
		315	HD-KORO-30-08S	HD-KORO-30-08S-SS	30	42x2	8	16x1.5
			HD-KORO-38-08S	HD-KORO-38-08S-SS	38	52x2	8	16x1.5
		630	HD-KORO-12-10S	HD-KORO-12-10S-SS	12	20x1.5	10	18x1.5
			HD-KORO-14-10S	HD-KORO-14-10S-SS	14	22x1.5	10	18x1.5
		400	HD-KORO-16-10S	HD-KORO-16-10S-SS	16	24x1.5	10	18x1.5
			HD-KORO-20-10S	HD-KORO-20-10S-SS	20	30x2	10	18x1.5
			HD-KORO-25-10S	HD-KORO-25-10S-SS	25	36x2	10	18x1.5
		250	HD-KORO-30-10S	HD-KORO-30-10S-SS	30	42x2	10	18x1.5
			HD-KORO-38-10S	HD-KORO-38-10S-SS	38	52x2	10	18x1.5
		630	HD-KORO-14-12S	HD-KORO-14-12S-SS	14	22x1.5	12	20x1.5
			HD-KORO-16-12S	HD-KORO-16-12S-SS	16	24x1.5	12	20x1.5
			HD-KORO-20-12S	HD-KORO-20-12S-SS	20	30x2	12	20x1.5
			HD-KORO-25-12S	HD-KORO-25-12S-SS	25	36x2	12	20x1.5
		400	HD-KORO-30-12S	HD-KORO-30-12S-SS	30	42x2	12	20x1.5
			HD-KORO-38-12S	HD-KORO-38-12S-SS	38	52x2	12	20x1.5
			HD-KORO-16-14S	HD-KORO-16-14S-SS	16	24x1.5	14	22x1.5
			HD-KORO-20-14S	HD-KORO-20-14S-SS	20	30x2	14	22x1.5
		250	HD-KORO-25-14S	HD-KORO-25-14S-SS	25	36x2	14	22x1.5
			HD-KORO-30-14S	HD-KORO-30-14S-SS	30	42x2	14	22x1.5
			HD-KORO-38-14S	HD-KORO-38-14S-SS	38	52x2	14	22x1.5
		400	HD-KORO-20-16S	HD-KORO-20-16S-SS	20	30x2	16	24x1.5
			HD-KORO-25-16S	HD-KORO-25-16S-SS	25	36x2	16	24x1.5
			HD-KORO-30-16S	HD-KORO-30-16S-SS	30	42x2	16	24x1.5
		315	HD-KORO-38-16S	HD-KORO-38-16S-SS	38	52x2	16	24x1.5
			HD-KORO-25-20S	HD-KORO-25-20S-SS	25	36x2	20	30x2
		400	HD-KORO-30-20S	HD-KORO-30-20S-SS	30	42x2	20	30x2
			HD-KORO-38-20S	HD-KORO-38-20S-SS	38	52x2	20	30x2
			HD-KORO-30-25S	HD-KORO-30-25S-SS	30	42x2	25	36x2
		315	HD-KORO-38-25S	HD-KORO-38-25S-SS	38	52x2	25	36x2
HD-KORO-38-30S	HD-KORO-38-30S-SS		38	52x2	30	42x2		

## HIGH PRESSURE - DIN 2353 connectors

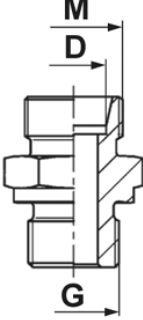
description	series	press. [bar]	code (galvanized steel)	code (AISI 316)	D [mm]	M [mm]	G [BSP]		
Connector with BSP thread, DIN 3852-B seal    <b>GE-BB</b>	L	315	HD-GE-06L-BB-02	HD-GE-06L-BB-02-SS	6	12x1.5	1/8		
			HD-GE-08L-BB-04	HD-GE-08L-BB-04-SS	8	14x1.5	1/4		
			HD-GE-10L-BB-04	HD-GE-10L-BB-04-SS	10	16x1.5	1/4		
			HD-GE-12L-BB-06	HD-GE-12L-BB-06-SS	12	18x1.5	3/8		
			HD-GE-15L-BB-08	HD-GE-15L-BB-08-SS	15	22x1.5	1/2		
			HD-GE-18L-BB-08	HD-GE-18L-BB-08-SS	18	26x1.5	1/2		
		160	HD-GE-22L-BB-12	HD-GE-22L-BB-12-SS	22	30x2	3/4		
			HD-GE-28L-BB-16	HD-GE-28L-BB-16-SS	28	36x2	1		
			HD-GE-35L-BB-20	HD-GE-35L-BB-20-SS	35	45x2	1.1/4		
			HD-GE-42L-BB-24	HD-GE-42L-BB-24-SS	42	52x2	1.1/2		
			S	630	HD-GE-06S-BB-04	HD-GE-06S-BB-04-SS	6	14x1.5	1/4
					HD-GE-08S-BB-04	HD-GE-08S-BB-04-SS	8	16x1.5	1/4
	HD-GE-10S-BB-06	HD-GE-10S-BB-06-SS			10	18x1.5	3/8		
	HD-GE-12S-BB-06	HD-GE-12S-BB-06-SS			12	20x1.5	3/8		
	HD-GE-14S-BB-08	HD-GE-14S-BB-08-SS			14	22x1.5	1/2		
	HD-GE-16S-BB-08	HD-GE-16S-BB-08-SS			16	24x1.5	1/2		
	400	HD-GE-20S-BB-12	HD-GE-20S-BB-12-SS	20	30x2	3/4			
		HD-GE-25S-BB-16	HD-GE-25S-BB-16-SS	25	36x2	1			
		HD-GE-30S-BB-20	HD-GE-30S-BB-20-SS	30	42x2	1.1/4			
		315	HD-GE-38S-BB-24	HD-GE-38S-BB-24-SS	38	52x2	1.1/2		

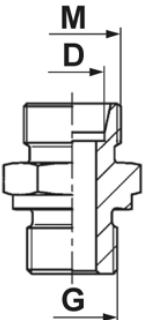
description	series	press. [bar]	code (galvanized steel)	code (AISI 316)	D [mm]	M [mm]	G [mm]		
Connector with metric thread, DIN 3852-B seal    <b>GE-MB</b>	L	315	HD-GE-06L-MB-10	HD-GE-06L-MB-10-SS	6	12x1.5	10x1		
			HD-GE-08L-MB-12	HD-GE-08L-MB-12-SS	8	14x1.5	12x1.5		
			HD-GE-10L-MB-14	HD-GE-10L-MB-14-SS	10	16x1.5	14x1.5		
			HD-GE-12L-MB-16	HD-GE-12L-MB-16-SS	12	18x1.5	16x1.5		
			HD-GE-15L-MB-18	HD-GE-15L-MB-18-SS	15	22x1.5	18x1.5		
			HD-GE-18L-MB-22	HD-GE-18L-MB-22-SS	18	26x1.5	22x1.5		
		160	HD-GE-22L-MB-26	HD-GE-22L-MB-26-SS	22	30x2	26x1.5		
			HD-GE-28L-MB-33	HD-GE-28L-MB-33-SS	28	36x2	33x2		
			HD-GE-35L-MB-42	HD-GE-35L-MB-42-SS	35	45x2	42x2		
			HD-GE-42L-MB-48	HD-GE-42L-MB-48-SS	42	52x2	48x2		
			S	630	HD-GE-06S-MB-12	HD-GE-06S-MB-12-SS	6	14x1.5	12x1.5
					HD-GE-08S-MB-14	HD-GE-08S-MB-14-SS	8	16x1.5	14x1.5
	HD-GE-10S-MB-16	HD-GE-10S-MB-16-SS			10	18x1.5	16x1.5		
	HD-GE-12S-MB-18	HD-GE-12S-MB-18-SS			12	20x1.5	18x1.5		
	HD-GE-14S-MB-20	HD-GE-14S-MB-20-SS			14	22x1.5	20x1.5		
	HD-GE-16S-MB-22	HD-GE-16S-MB-22-SS			16	24x1.5	22x1.5		
	400	HD-GE-20S-MB-27	HD-GE-20S-MB-27-SS	20	30x2	27x2			
		HD-GE-25S-MB-33	HD-GE-25S-MB-33-SS	25	36x2	33x2			
		HD-GE-30S-MB-42	HD-GE-30S-MB-42-SS	30	42x2	42x2			
		315	HD-GE-38S-MB-48	HD-GE-38S-MB-48-SS	38	52x2	48x2		

# HIGH PRESSURE - DIN 2353 connectors

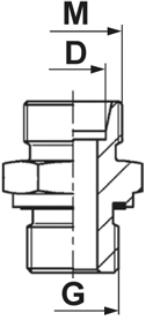
description	series	press. [bar]	code (galvanized steel)	code (AISI 316)	D [mm]	M [mm]	G [BSP]
Connector with BSP thread, DIN 3852-E seal  	LL	100	HD-GE-04LL-BE-02	HD-GE-04LL-BE-02-SS	4	8x1	1/8
			HD-GE-06LL-BE-02	HD-GE-06LL-BE-02-SS	6	10x1	1/8
			HD-GE-08LL-BE-02	HD-GE-08LL-BE-02-SS	8	12x1	1/8
	L	315	HD-GE-06L-BE-02	HD-GE-06L-BE-02-SS	6	2x1.5	1/8
			HD-GE-08L-BE-04	HD-GE-08L-BE-04-SS	8	14x1.5	1/4
			HD-GE-10L-BE-04	HD-GE-10L-BE-04-SS	10	16x1.5	1/4
			HD-GE-12L-BE-06	HD-GE-12L-BE-06-SS	12	18x1.5	3/8
			HD-GE-15L-BE-08	HD-GE-15L-BE-08-SS	15	22x1.5	1/2
			HD-GE-18L-BE-08	HD-GE-18L-BE-08-SS	18	26x1.5	1/2
			HD-GE-22L-BE-12	HD-GE-22L-BE-12-SS	22	30x2	3/4
			HD-GE-28L-BE-16	HD-GE-28L-BE-16-SS	28	36x2	1
			HD-GE-35L-BE-20	HD-GE-35L-BE-20-SS	35	45x2	1.1/4
	S	630	HD-GE-06S-BE-04	HD-GE-06S-BE-04-SS	6	14x1.5	1/4
			HD-GE-08S-BE-04	HD-GE-08S-BE-04-SS	8	16x1.5	1/4
			HD-GE-10S-BE-06	HD-GE-10S-BE-06-SS	10	18x1.5	3/8
			HD-GE-12S-BE-06	HD-GE-12S-BE-06-SS	12	20x1.5	3/8
			HD-GE-14S-BE-08	HD-GE-14S-BE-08-SS	14	22x1.5	1/2
			HD-GE-16S-BE-08	HD-GE-16S-BE-08-SS	16	24x1.5	1/2
		400	HD-GE-20S-BE-12	HD-GE-20S-BE-12-SS	20	30x2	3/4
			HD-GE-25S-BE-16	HD-GE-25S-BE-16-SS	25	36x2	1
			HD-GE-30S-BE-20	HD-GE-30S-BE-20-SS	30	42x2	1.1/4
			HD-GE-38S-BE-24	HD-GE-38S-BE-24-SS	38	52x2	1.1/2

**GE-BE**

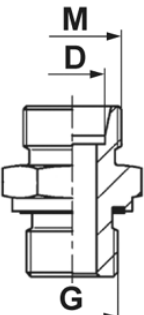
description	series	press. [bar]	code (galvanized steel)	code (AISI 316)	D [mm]	M [mm]	G [mm]
Connector with metric thread, DIN 3852-E seal  	LL	100	HD-GE-04LL-ME-08	HD-GE-04LL-ME-08-SS	4	8x1	8x1
			HD-GE-06LL-ME-10	HD-GE-06LL-ME-10-SS	6	10x1	10x1
			HD-GE-08LL-ME-10	HD-GE-08LL-ME-10-SS	8	12x1	10x1
	L	315	HD-GE-06L-ME-10	HD-GE-06L-ME-10-SS	6	12x1.5	10x1
			HD-GE-08L-ME-12	HD-GE-08L-ME-12-SS	8	14x1.5	12x1.5
			HD-GE-10L-ME-14	HD-GE-10L-ME-14-SS	10	16x1.5	14x1.5
			HD-GE-12L-ME-16	HD-GE-12L-ME-16-SS	12	18x1.5	16x1.5
			HD-GE-15L-ME-18	HD-GE-15L-ME-18-SS	15	22x1.5	18x1.5
			HD-GE-18L-ME-22	HD-GE-18L-ME-22-SS	18	26x1.5	22x1.5
			HD-GE-22L-ME-26	HD-GE-22L-ME-26-SS	22	30x2	26x1.5
			HD-GE-28L-ME-33	HD-GE-28L-ME-33-SS	28	36x2	33x2
			HD-GE-35L-ME-42	HD-GE-35L-ME-42-SS	35	45x2	42x2
	S	630	HD-GE-06S-ME-12	HD-GE-06S-ME-12-SS	6	14x1.5	12x1.5
			HD-GE-08S-ME-14	HD-GE-08S-ME-14-SS	8	16x1.5	14x1.5
			HD-GE-10S-ME-16	HD-GE-10S-ME-16-SS	10	18x1.5	16x1.5
			HD-GE-12S-ME-18	HD-GE-12S-ME-18-SS	12	20x1.5	18x1.5
			HD-GE-14S-ME-20	HD-GE-14S-ME-20-SS	14	22x1.5	20x1.5
			HD-GE-16S-ME-22	HD-GE-16S-ME-22-SS	16	24x1.5	22x1.5
		400	HD-GE-20S-ME-27	HD-GE-20S-ME-27-SS	20	30x2	27x2
			HD-GE-25S-ME-33	HD-GE-25S-ME-33-SS	25	36x2	33x2
			HD-GE-30S-ME-42	HD-GE-30S-ME-42-SS	30	42x2	42x2
			HD-GE-38S-ME-48	HD-GE-38S-ME-48-SS	38	52x2	48x2

**GE-ME**

# HIGH PRESSURE - DIN 2353 connectors

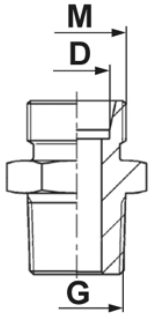
description	series	press. [bar]	code (galvanized steel)	code (AISI 316)	D [mm]	M [mm]	G [BSPT]		
Connector with BSPT tapered thread    <b>GE-BT</b>	L	315	HD-GE-06L-BT-02	HD-GE-06L-BT-02-SS	6	12x1.5	1/8		
			HD-GE-08L-BT-04	HD-GE-08L-BT-04-SS	8	14x1.5	1/4		
			HD-GE-10L-BT-04	HD-GE-10L-BT-04-SS	10	16x1.5	1/4		
			HD-GE-12L-BT-06	HD-GE-12L-BT-06-SS	12	18x1.5	3/8		
			HD-GE-15L-BT-08	HD-GE-15L-BT-08-SS	15	22x1.5	1/2		
			HD-GE-18L-BT-08	HD-GE-18L-BT-08-SS	18	26x1.5	1/2		
		160	HD-GE-22L-BT-12	HD-GE-22L-BT-12-SS	22	30x2	3/4		
			HD-GE-28L-BT-16	HD-GE-28L-BT-16-SS	28	36x2	1		
			HD-GE-35L-BT-20	HD-GE-35L-BT-20-SS	35	45x2	1.1/4		
			HD-GE-42L-BT-24	HD-GE-42L-BT-24-SS	42	52x2	1.1/2		
			S	630	HD-GE-06S-BT-04	HD-GE-06S-BT-04-SS	6	14x1.5	1/4
					HD-GE-08S-BT-04	HD-GE-08S-BT-04-SS	8	16x1.5	1/4
	HD-GE-10S-BT-06	HD-GE-10S-BT-06-SS			10	18x1.5	3/8		
	HD-GE-12S-BT-06	HD-GE-12S-BT-06-SS			12	20x1.5	3/8		
	HD-GE-14S-BT-08	HD-GE-14S-BT-08-SS			14	22x1.5	1/2		
	400	HD-GE-16S-BT-08			HD-GE-16S-BT-08-SS	16	24x1.5	1/2	
		HD-GE-20S-BT-12	HD-GE-20S-BT-12-SS	20	30x2	3/4			
		HD-GE-25S-BT-16	HD-GE-25S-BT-16-SS	25	36x2	1			
		HD-GE-30S-BT-20	HD-GE-30S-BT-20-SS	30	42x2	1.1/4			
		315	HD-GE-38S-BT-24	HD-GE-38S-BT-24-SS	38	52x2	1.1/2		

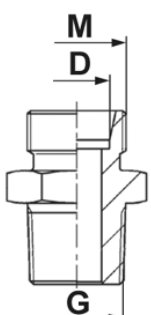
description	series	press. [bar]	code (galvanized steel)	code (AISI 316)	D [mm]	M [mm]	G [NPT]		
Connector with NPT tapered thread    <b>GE-NT</b>	L	315	HD-GE-06L-NT-02	HD-GE-06L-NT-02-SS	6	12x1.5	1/8		
			HD-GE-08L-NT-04	HD-GE-08L-NT-04-SS	8	14x1.5	1/4		
			HD-GE-10L-NT-04	HD-GE-10L-NT-04-SS	10	16x1.5	1/4		
			HD-GE-12L-NT-06	HD-GE-12L-NT-06-SS	12	18x1.5	3/8		
			HD-GE-15L-NT-08	HD-GE-15L-NT-08-SS	15	22x1.5	1/2		
			HD-GE-18L-NT-08	HD-GE-18L-NT-08-SS	18	26x1.5	1/2		
		160	HD-GE-22L-NT-12	HD-GE-22L-NT-12-SS	22	30x2	3/4		
			HD-GE-28L-NT-16	HD-GE-28L-NT-16-SS	28	36x2	1		
			HD-GE-35L-NT-20	HD-GE-35L-NT-20-SS	35	45x2	1.1/4		
			HD-GE-42L-NT-24	HD-GE-42L-NT-24-SS	42	52x2	1.1/2		
			S	630	HD-GE-06S-NT-04	HD-GE-06S-NT-04-SS	6	14x1.5	1/4
					HD-GE-08S-NT-04	HD-GE-08S-NT-04-SS	8	16x1.5	1/4
	HD-GE-10S-NT-06	HD-GE-10S-NT-06-SS			10	18x1.5	3/8		
	HD-GE-12S-NT-06	HD-GE-12S-NT-06-SS			12	20x1.5	3/8		
	HD-GE-14S-NT-08	HD-GE-14S-NT-08-SS			14	22x1.5	1/2		
	400	HD-GE-16S-NT-08			HD-GE-16S-NT-08-SS	16	24x1.5	1/2	
		HD-GE-20S-NT-12	HD-GE-20S-NT-12-SS	20	30x2	3/4			
		HD-GE-25S-NT-16	HD-GE-25S-NT-16-SS	25	36x2	1			
		HD-GE-30S-NT-20	HD-GE-30S-NT-20-SS	30	42x2	1.1/4			
		315	HD-GE-38S-NT-24	HD-GE-38S-NT-24-SS	38	52x2	1.1/2		

# HIGH PRESSURE - DIN 2353 connectors

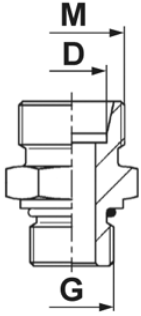
description	series	press. [bar]	code (galvanized steel)	code (AISI 316)	D [mm]	M [mm]	G [UN-UNF]
Connector with UN-UNF thread, O-ring seal    <b>GE-UN</b>	L	315	HD-GE-06L-UN-07	HD-GE-06L-UN-07-SS	6	12x1.5	7/16-20
			HD-GE-08L-UN-08	HD-GE-08L-UN-08-SS	8	14x1.5	1/2-20
			HD-GE-10L-UN-08	HD-GE-10L-UN-08-SS	10	16x1.5	1/2-20
			HD-GE-12L-UN-09	HD-GE-12L-UN-09-SS	12	18x1.5	9/16-18
			HD-GE-15L-UN-12	HD-GE-15L-UN-12-SS	15	22x1.5	3/4-16
			HD-GE-18L-UN-12	HD-GE-18L-UN-12-SS	18	26x1.5	3/4-16
		160	HD-GE-22L-UN-17	HD-GE-22L-UN-17-SS	22	30x2	1.1/16-12
			HD-GE-28L-UN-21	HD-GE-28L-UN-21-SS	28	36x2	1.5/16-12
			HD-GE-35L-UN-26	HD-GE-35L-UN-26-SS	35	45x2	1.5/8-12
			HD-GE-42L-UN-30	HD-GE-42L-UN-30-SS	42	52x2	1.7/8-12
	S	630	HD-GE-06S-UN-08	HD-GE-06S-UN-08-SS	6	14x1.5	1/2-20
			HD-GE-08S-UN-08	HD-GE-08S-UN-08-SS	8	16x1.5	1/2-20
			HD-GE-10S-UN-09	HD-GE-10S-UN-09-SS	10	18x1.5	9/16-18
			HD-GE-12S-UN-09	HD-GE-12S-UN-09-SS	12	20x1.5	9/16-18
			HD-GE-14S-UN-12	HD-GE-14S-UN-12-SS	14	22x1.5	3/4-16
		400	HD-GE-16S-UN-12	HD-GE-16S-UN-12-SS	16	24x1.5	3/4-16
			HD-GE-20S-UN-17	HD-GE-20S-UN-17-SS	20	30x2	1.1/16-12
			HD-GE-25S-UN-21	HD-GE-25S-UN-21-SS	25	36x2	1.5/16-12
			HD-GE-30S-UN-26	HD-GE-30S-UN-26-SS	30	42x2	1.5/8-12
			HD-GE-38S-UN-30	HD-GE-38S-UN-30-SS	38	52x2	1.7/8-12

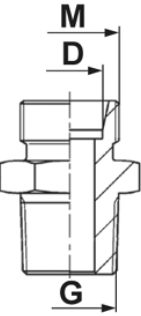
description	series	press. [bar]	code (galvanized steel)	code (AISI 316)	D [mm]	M [mm]	G [mm]
Connector with metric tapered thread    <b>GE-MT</b>	L	315	HD-GE-06L-MT-10	HD-GE-06L-MT-10-SS	6	12x1.5	10x1
			HD-GE-08L-MT-12	HD-GE-08L-MT-12-SS	8	14x1.5	12x1.5
			HD-GE-10L-MT-14	HD-GE-10L-MT-14-SS	10	16x1.5	14x1.5
			HD-GE-12L-MT-16	HD-GE-12L-MT-16-SS	12	18x1.5	16x1.5
			HD-GE-15L-MT-18	HD-GE-15L-MT-18-SS	15	22x1.5	18x1.5
			HD-GE-18L-MT-22	HD-GE-18L-MT-22-SS	18	26x1.5	22x1.5
	M	630	HD-GE-06S-MT-12	HD-GE-06S-MT-12-SS	6	14x1.5	12x1.5
			HD-GE-08S-MT-14	HD-GE-08S-MT-14-SS	8	16x1.5	14x1.5
			HD-GE-10S-MT-16	HD-GE-10S-MT-16-SS	10	18x1.5	16x1.5
			HD-GE-12S-MT-18	HD-GE-12S-MT-18-SS	12	20x1.5	18x1.5
			HD-GE-14S-MT-20	HD-GE-14S-MT-20-SS	14	22x1.5	20x1.5
		400	HD-GE-16S-MT-22	HD-GE-16S-MT-22-SS	16	24x1.5	22x1.5

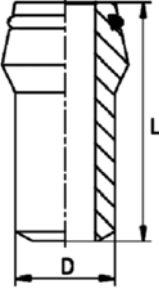

## HIGH PRESSURE - DIN 2353 connectors

description	series	press. [bar]	code (black steel)	code (AISI 316)	D [mm]	g [mm]	L [mm]
Connector with weld-in end. 24° cone. o-ring seal  	L/S	520	HD-ASF-06X1,75	-	6	1.75	31
			-	HD-ASF-06X1,5-SS	6	1.5	31
			HD-ASF-08X2,0	HD-ASF-08X2,0-SS	8	2.0	31
		315	HD-ASF-10X1,5	HD-ASF-10X1,5-SS	10	1.5	32.5
		400	HD-ASF-10X2,0	HD-ASF-10X2,0-SS	10	2.0	32.5
		315	HD-ASF-12X1,5	HD-ASF-12X1,5-SS	12	1.5	32.5
		400	HD-ASF-12X2,0	HD-ASF-12X2,0-SS	12	2.0	32.5
	470	HD-ASF-12X2,5	HD-ASF-12X2,5-SS	12	2.5	32.5	
	L	315	HD-ASF-15X2,5	HD-ASF-15X2,5-SS	15	2.5	34
			HD-ASF-18X2,5	HD-ASF-18X2,5-SS	18	2.5	35.5
		160	HD-ASF-22X2,5	HD-ASF-22X2,5-SS	22	2.5	38.5
			HD-ASF-28X2,5	HD-ASF-28X2,5-SS	28	2.5	41.5
			HD-ASF-35X3,0	HD-ASF-35X3,0-SS	35	3.0	47.5
	S	400	HD-ASF-42X3,0	HD-ASF-42X3,0-SS	42	3.0	47.5
			HD-ASF-14X3,0	HD-ASF-14X3,0-SS	14	3.0	38.5
		250	HD-ASF-16X2,0	HD-ASF-16X2,0-SS	16	2.0	39
		315	HD-ASF-16X2,5	HD-ASF-16X2,5-SS	16	2.5	39
		400	HD-ASF-16X3,0	HD-ASF-16X3,0-SS	16	3.0	39
		250	HD-ASF-20X2,5	HD-ASF-20X2,5-SS	20	2.5	45
		315	HD-ASF-20X3,0	HD-ASF-20X3,0-SS	20	3.0	45
		400	HD-ASF-20X4,0	HD-ASF-20X4,0-SS	20	4.0	45
		250	HD-ASF-25X3,0	HD-ASF-25X3,0-SS	25	3.0	49.5
		315	HD-ASF-25X4,0	HD-ASF-25X4,0-SS	25	4.0	49.5
		400	HD-ASF-25X5,0	HD-ASF-25X5,0-SS	25	5.0	49.5
		160	HD-ASF-30X3,0	HD-ASF-30X3,0-SS	30	3.0	52
		250	HD-ASF-30X4,0	HD-ASF-30X4,0-SS	30	4.0	52
		315	HD-ASF-30X5,0	HD-ASF-30X5,0-SS	30	5.0	52
			HD-ASF-30X6,0	HD-ASF-30X6,0-SS	30	6.0	52
		250	HD-ASF-38X5,0	HD-ASF-38X5,0-SS	38	5.0	56.5
	315	HD-ASF-38X6,0	HD-ASF-38X6,0-SS	38	6.0	56.5	

**ASF**

# HIGH PRESSURE - DIN 2353 connectors

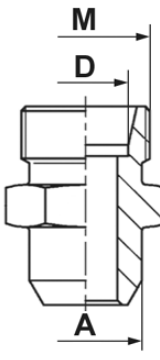
description	series	press. [bar]	code (black steel)	code (AISI 316)	D [mm]	M [mm]	A [mm]
Connector with weld-in end  	L	315	HD-AS-06L	HD-AS-06L-SS	6	12x1.5	10
			HD-AS-08L	HD-AS-08L-SS	8	14x1.5	12
			HD-AS-10L	HD-AS-10L-SS	10	16x1.5	14
			HD-AS-12L	HD-AS-12L-SS	12	18x1.5	16
			HD-AS-15L	HD-AS-15L-SS	15	22x1.5	19
			HD-AS-18L	HD-AS-18L-SS	18	26x1.5	22
		160	HD-AS-22L	HD-AS-22L-SS	22	30x2	27
			HD-AS-28L	HD-AS-28L-SS	28	36x2	32
			HD-AS-35L	HD-AS-35L-SS	35	45x2	40
			HD-AS-42L	HD-AS-42L-SS	42	52x2	46
	S	630	HD-AS-06S	HD-AS-06S-SS	6	14x1.5	11
			HD-AS-08S	HD-AS-08S-SS	8	16x1.5	13
			HD-AS-10S	HD-AS-10S-SS	10	18x1.5	15
			HD-AS-12S	HD-AS-12S-SS	12	20x1.5	17
			HD-AS-14S	HD-AS-14S-SS	14	22x1.5	19
		400	HD-AS-16S	HD-AS-16S-SS	16	24x1.5	21
			HD-AS-20S	HD-AS-20S-SS	20	30x2	26
			HD-AS-25S	HD-AS-25S-SS	25	36x2	31
			HD-AS-30S	HD-AS-30S-SS	30	42x2	36
			HD-AS-38S	HD-AS-38S-SS	38	52x2	44

**AS**

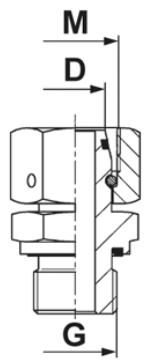
description	series	press. [bar]	code (galvanized steel)	code (AISI 316)	D [mm]	M [mm]	G [BSP]
Adjustable metric connector with BSP thread, DIN 3852-E seal  	L	315	HD-EVGEO-06L-BE-02	HD-EVGEO-06L-BE-02-SS	6	12x1.5	1/8
			HD-EVGEO-08L-BE-04	HD-EVGEO-08L-BE-04-SS	8	14x1.5	1/4
			HD-EVGEO-10L-BE-04	HD-EVGEO-10L-BE-04-SS	10	16x1.5	1/4
			HD-EVGEO-12L-BE-06	HD-EVGEO-12L-BE-06-SS	12	18x1.5	3/8
			HD-EVGEO-15L-BE-08	HD-EVGEO-15L-BE-08-SS	15	22x1.5	1/2
			HD-EVGEO-18L-BE-08	HD-EVGEO-18L-BE-08-SS	18	26x1.5	1/2
		160	HD-EVGEO-22L-BE-12	HD-EVGEO-22L-BE-12-SS	22	30x2	3/4
			HD-EVGEO-28L-BE-16	HD-EVGEO-28L-BE-16-SS	28	36x2	1
			HD-EVGEO-35L-BE-20	HD-EVGEO-35L-BE-20-SS	35	45x2	1.1/4
			HD-EVGEO-42L-BE-24	HD-EVGEO-42L-BE-24-SS	42	52x2	1.1/2
	S	630	HD-EVGEO-06S-BE-04	HD-EVGEO-06S-BE-04-SS	6	14x1.5	1/4
			HD-EVGEO-08S-BE-04	HD-EVGEO-08S-BE-04-SS	8	16x1.5	1/4
			HD-EVGEO-10S-BE-06	HD-EVGEO-10S-BE-06-SS	10	18x1.5	3/8
			HD-EVGEO-12S-BE-06	HD-EVGEO-12S-BE-06-SS	12	20x1.5	3/8
			HD-EVGEO-14S-BE-08	HD-EVGEO-14S-BE-08-SS	14	22x1.5	1/2
		400	HD-EVGEO-16S-BE-08	HD-EVGEO-16S-BE-08-SS	16	24x1.5	1/2
			HD-EVGEO-20S-BE-12	HD-EVGEO-20S-BE-12-SS	20	30x2	3/4
			HD-EVGEO-25S-BE-16	HD-EVGEO-25S-BE-16-SS	25	36x2	1
			HD-EVGEO-30S-BE-20	HD-EVGEO-30S-BE-20-SS	30	42x2	1.1/4
			HD-EVGEO-38S-BE-24	HD-EVGEO-38S-BE-24-SS	38	52x2	1.1/2

**EVGEO - BE**

## HIGH PRESSURE - DIN 2353 connectors

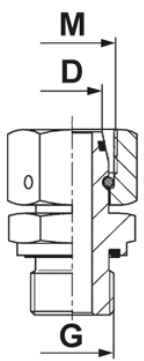
description	series	press. [bar]	code (galvanized steel)	code (AISI 316)	D [mm]	M [mm]	G [mm]		
Adjustable connector with metric thread, DIN 3852-E seal  	L	315	HD-EVGEO-06L-ME-10	HD-EVGEO-06L-ME-10-SS	6	12x1.5	10x1		
			HD-EVGEO-08L-ME-12	HD-EVGEO-08L-ME-12-SS	8	14x1.5	12x1.5		
			HD-EVGEO-10L-ME-14	HD-EVGEO-10L-ME-14-SS	10	16x1.5	14x1.5		
			HD-EVGEO-12L-ME-16	HD-EVGEO-12L-ME-16-SS	12	18x1.5	16x1.5		
			HD-EVGEO-15L-ME-18	HD-EVGEO-15L-ME-18-SS	15	22x1.5	18x1.5		
			HD-EVGEO-18L-ME-22	HD-EVGEO-18L-ME-22-SS	18	26x1.5	22x1.5		
		160	HD-EVGEO-22L-ME-26	HD-EVGEO-22L-ME-26-SS	22	30x2	26x1.5		
			HD-EVGEO-28L-ME-33	HD-EVGEO-28L-ME-33-SS	28	36x2	33x2		
			HD-EVGEO-35L-ME-42	HD-EVGEO-35L-ME-42-SS	35	45x2	42x2		
			HD-EVGEO-42L-ME-48	HD-EVGEO-42L-ME-48-SS	42	52x2	48x2		
			S	630	HD-EVGEO-06S-ME-12	HD-EVGEO-06S-ME-12-SS	6	14x1.5	12x1.5
					HD-EVGEO-08S-ME-14	HD-EVGEO-08S-ME-14-SS	8	16x1.5	14x1.5
	HD-EVGEO-10S-ME-16	HD-EVGEO-10S-ME-16-SS			10	18x1.5	16x1.5		
	HD-EVGEO-12S-ME-18	HD-EVGEO-12S-ME-18-SS			12	20x1.5	18x1.5		
	HD-EVGEO-14S-ME-20	HD-EVGEO-14S-ME-20-SS			14	22x1.5	20x1.5		
	HD-EVGEO-16S-ME-22	HD-EVGEO-16S-ME-22-SS			16	24x1.5	22x1.5		
	400	HD-EVGEO-20S-ME-27	HD-EVGEO-20S-ME-27-SS	20	30x2	27x2			
		HD-EVGEO-25S-ME-33	HD-EVGEO-25S-ME-33-SS	25	36x2	33x2			
		HD-EVGEO-30S-ME-42	HD-EVGEO-30S-ME-42-SS	30	42x2	42x2			
		315	HD-EVGEO-38S-ME-48	HD-EVGEO-38S-ME-48-SS	38	52x2	48x2		

**EVGEO - ME**

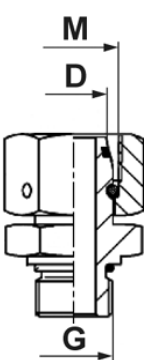
description	series	press. [bar]	code (galvanized steel)	code (AISI 316)	D [mm]	M [mm]	G [UN-UNF]		
Adjustable connector with UN-UNF thread, O-ring seal  	L	315	HD-EVGEO-06L-UN-07	HD-EVGEO-06L-UN-07-SS	6	12x1.5	7/16-20		
			HD-EVGEO-08L-UN-07	HD-EVGEO-08L-UN-07-SS	8	14x1.5	7/16-20		
			HD-EVGEO-10L-UN-09	HD-EVGEO-10L-UN-09-SS	10	16x1.5	9/16-18		
			HD-EVGEO-12L-UN-12	HD-EVGEO-12L-UN-12-SS	12	18x1.5	3/4-16		
			HD-EVGEO-15L-UN-14	HD-EVGEO-15L-UN-14-SS	15	22x1.5	7/8-14		
			HD-EVGEO-18L-UN-14	HD-EVGEO-18L-UN-14-SS	18	26x1.5	7/8-14		
		160	HD-EVGEO-22L-UN-17	HD-EVGEO-22L-UN-17-SS	22	30x2	1.1/16-12		
			HD-EVGEO-28L-UN-21	HD-EVGEO-28L-UN-21-SS	28	36x2	1.5/16-12		
			HD-EVGEO-35L-UN-26	HD-EVGEO-35L-UN-26-SS	35	45x2	1.5/8-12		
			HD-EVGEO-42L-UN-30	HD-EVGEO-42L-UN-30-SS	42	52x2	1.7/8-12		
			S	630	HD-EVGEO-06S-UN-07	HD-EVGEO-06S-UN-07-SS	6	14x1.5	7/16-20
					HD-EVGEO-08S-UN-09	HD-EVGEO-08S-UN-09-SS	8	16x1.5	9/16-18
	HD-EVGEO-10S-UN-09	HD-EVGEO-10S-UN-09-SS			10	18x1.5	9/16-18		
	HD-EVGEO-12S-UN-12	HD-EVGEO-12S-UN-12-SS			12	20x1.5	3/4-16		
	HD-EVGEO-14S-UN-14	HD-EVGEO-14S-UN-14-SS			14	22x1.5	7/8-14		
	HD-EVGEO-16S-UN-14	HD-EVGEO-16S-UN-14-SS			16	24x1.5	7/8-14		
	400	HD-EVGEO-20S-UN-17	HD-EVGEO-20S-UN-17-SS	20	30x2	1.1/16-12			
		HD-EVGEO-25S-UN-21	HD-EVGEO-25S-UN-21-SS	25	36x2	1.5/16-12			
		HD-EVGEO-30S-UN-26	HD-EVGEO-30S-UN-26-SS	30	42x2	1.5/8-12			
		315	HD-EVGEO-38S-UN-30	HD-EVGEO-38S-UN-30-SS	38	52x2	1.7/8-12		

**EVGEO - UN**

# HIGH PRESSURE - DIN 2353 connectors

description	series	press. [bar]	code (galvanized steel)	code (AISI 316)	D [mm]	M [mm]	G [BSP]		
Connector with BSP female thread    <b>GAI - B</b>	L	315	HD-GAI-06L-B-02	HD-GAI-06L-B-02-SS	6	12x1.5	1/8		
			HD-GAI-08L-B-04	HD-GAI-08L-B-04-SS	8	14x1.5	1/4		
			HD-GAI-10L-B-04	HD-GAI-10L-B-04-SS	10	16x1.5	1/4		
			HD-GAI-12L-B-06	HD-GAI-12L-B-06-SS	12	18x1.5	3/8		
			HD-GAI-15L-B-08	HD-GAI-15L-B-08-SS	15	22x1.5	1/2		
			HD-GAI-18L-B-08	HD-GAI-18L-B-08-SS	18	26x1.5	1/2		
		160	HD-GAI-22L-B-12	HD-GAI-22L-B-12-SS	22	30x2	3/4		
			HD-GAI-28L-B-16	HD-GAI-28L-B-16-SS	28	36x2	1		
			HD-GAI-35L-B-20	HD-GAI-35L-B-20-SS	35	45x2	1.1/4		
			HD-GAI-42L-B-24	HD-GAI-42L-B-24-SS	42	52x2	1.1/2		
			S	630	HD-GAI-06S-B-04	HD-GAI-06S-B-04-SS	6	14x1.5	1/4
					HD-GAI-08S-B-04	HD-GAI-08S-B-04-SS	8	16x1.5	1/4
	HD-GAI-10S-B-06	HD-GAI-10S-B-06-SS			10	18x1.5	3/8		
	400	HD-GAI-12S-B-06		HD-GAI-12S-B-06-SS	12	20x1.5	3/8		
		HD-GAI-14S-B-08		HD-GAI-14S-B-08-SS	14	22x1.5	1/2		
		HD-GAI-16S-B-08		HD-GAI-16S-B-08-SS	16	24x1.5	1/2		
	315	HD-GAI-20S-B-12	HD-GAI-20S-B-12-SS	20	30x2	3/4			
		HD-GAI-25S-B-16	HD-GAI-25S-B-16-SS	25	36x2	1			
		HD-GAI-30S-B-20	HD-GAI-30S-B-20-SS	30	42x2	1.1/4			
		HD-GAI-38S-B-24	HD-GAI-38S-B-24-SS	38	52x2	1.1/2			

description	series	press. [bar]	code (galvanized steel)	code (AISI 316)	D [mm]	M [mm]	G [mm]		
Connector with metric female thread    <b>GAI - M</b>	L	315	HD-GAI-06L-M-10	HD-GAI-06L-M-10-SS	6	12x1.5	10x1		
			HD-GAI-08L-M-12	HD-GAI-08L-M-12-SS	8	14x1.5	12x1.5		
			HD-GAI-10L-M-14	HD-GAI-10L-M-14-SS	10	16x1.5	14x1.5		
			HD-GAI-12L-M-16	HD-GAI-12L-M-16-SS	12	18x1.5	16x1.5		
			HD-GAI-15L-M-18	HD-GAI-15L-M-18-SS	15	22x1.5	18x1.5		
			HD-GAI-18L-M-22	HD-GAI-18L-M-22-SS	18	26x1.5	22x1.5		
		160	HD-GAI-22L-M-26	HD-GAI-22L-M-26-SS	22	30x2	26x1.5		
			HD-GAI-28L-M-33	HD-GAI-28L-M-33-SS	28	36x2	33x2		
			HD-GAI-35L-M-42	HD-GAI-35L-M-42-SS	35	45x2	42x2		
			HD-GAI-42L-M-48	HD-GAI-42L-M-48-SS	42	52x2	48x2		
			S	630	HD-GAI-06S-M-12	HD-GAI-06S-M-12-SS	6	14x1.5	12x1.5
					HD-GAI-08S-M-14	HD-GAI-08S-M-14-SS	8	16x1.5	14x1.5
	HD-GAI-10S-M-16	HD-GAI-10S-M-16-SS			10	18x1.5	16x1.5		
	400	HD-GAI-12S-M-18		HD-GAI-12S-M-18-SS	12	20x1.5	18x1.5		
		HD-GAI-14S-M-20		HD-GAI-14S-M-20-SS	14	22x1.5	20x1.5		
		HD-GAI-16S-M-22		HD-GAI-16S-M-22-SS	16	24x1.5	22x1.5		
	315	HD-GAI-20S-M-27	HD-GAI-20S-M-27-SS	20	30x2	27x2			
		HD-GAI-25S-M-33	HD-GAI-25S-M-33-SS	25	36x2	33x2			
		HD-GAI-30S-M-42	HD-GAI-30S-M-42-SS	30	42x2	42x2			
		HD-GAI-38S-M-48	HD-GAI-38S-M-48-SS	38	52x2	48x2			

## HIGH PRESSURE - DIN 2353 connectors

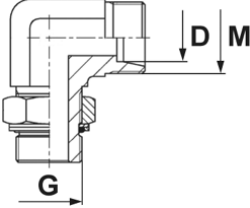
description	series	press. [bar]	code (galvanized steel)	code (AISI 316)	D [mm]	M [mm]	G [BSP]	
Adjustable 90° connector with BSP thread, ISO 1179-G seal  	L	315	HD-WE-06L-BG-02	-	6	12x1.5	1/8	
			HD-WE-08L-BG-04	-	8	14x1.5	1/4	
			HD-WE-10L-BG-04	-	10	16x1.5	1/4	
		250	HD-WE-12L-BG-06	-	12	18x1.5	3/8	
			HD-WE-15L-BG-08	-	15	22x1.5	1/2	
			HD-WE-18L-BG-08	-	18	26x1.5	1/2	
		160	HD-WE-22L-BG-12	-	22	30x2	3/4	
			HD-WE-28L-BG-16	-	28	36x2	1	
			HD-WE-35L-BG-20	-	35	45x2	1.1/4	
			HD-WE-42L-BG-24	-	42	52x2	1.1/2	
		S	315	HD-WE-06S-BG-04	-	6	14x1.5	1/4
				HD-WE-08S-BG-04	-	8	16x1.5	1/4
	250		HD-WE-10S-BG-06	-	10	18x1.5	3/8	
			HD-WE-12S-BG-06	-	12	20x1.5	3/8	
			HD-WE-14S-BG-08	-	14	22x1.5	1/2	
			HD-WE-16S-BG-08	-	16	24x1.5	1/2	
	200		HD-WE-20S-BG-12	-	20	30x2	3/4	
			HD-WE-25S-BG-16	-	25	36x2	1	
	160		HD-WE-30S-BG-20	-	30	42x2	1.1/4	
			HD-WE-38S-BG-24	-	38	52x2	1.1/2	

**WE - BG**

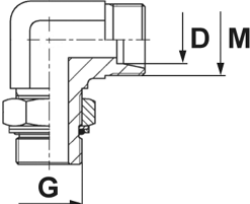
description	series	press. [bar]	code (galvanized steel)	code (AISI 316)	D [mm]	M [mm]	G [mm]		
Adjustable 90° connector with metric thread, ISO 6149-G seal  	L	315	HD-WE-06L-MG-10	-	6	12x1.5	10x1		
			HD-WE-08L-MG-12	-	8	14x1.5	12x1.5		
			HD-WE-10L-MG-14	-	10	16x1.5	14x1.5		
			HD-WE-12L-MG-16	-	12	18x1.5	16x1.5		
			HD-WE-15L-MG-18	-	15	22x1.5	18x1.5		
		250	HD-WE-18L-MG-22	-	18	26x1.5	22x1.5		
			HD-WE-22L-MG-27	-	22	30x2	27x2		
			HD-WE-28L-MG-33	-	28	36x2	33x2		
		160	HD-WE-35L-MG-42	-	35	45x2	42x2		
			HD-WE-42L-MG-48	-	42	52x2	48x2		
			S	315	HD-WE-06S-MG-12	-	6	14x1.5	12x1.5
					HD-WE-08S-MG-14	-	8	16x1.5	14x1.5
	HD-WE-10S-MG-16	-			10	18x1.5	16x1.5		
	250	HD-WE-12S-MG-18		-	12	20x1.5	18x1.5		
		HD-WE-14S-MG-20	-	14	22x1.5	20x1.5			
		HD-WE-16S-MG-22	-	16	24x1.5	22x1.5			
	160	HD-WE-20S-MG-27	-	20	30x2	27x2			
		HD-WE-25S-MG-33	-	25	36x2	33x2			
		HD-WE-30S-MG-42	-	30	42x2	42x2			
		HD-WE-38S-MG-48	-	38	52x2	48x2			

**WE - MG**

# HIGH PRESSURE - DIN 2353 connectors

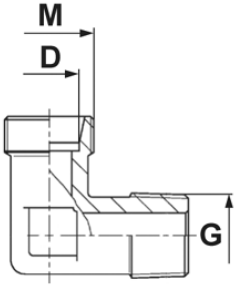
description	series	press. [bar]	code (galvanized steel)	code (AISI 316)	D [mm]	M [mm]	G [BSPT]
90° connector with BSPT tapered thread    <b>WE - BT</b>	L	315	HD-WE-06L-BT-02	HD-WE-06L-BT-02-SS	6	12x1.5	1/8
			HD-WE-08L-BT-04	HD-WE-08L-BT-04-SS	8	14x1.5	1/4
			HD-WE-10L-BT-04	HD-WE-10L-BT-04-SS	10	16x1.5	1/4
			HD-WE-12L-BT-06	HD-WE-12L-BT-06-SS	12	18x1.5	3/8
			HD-WE-15L-BT-08	HD-WE-15L-BT-08-SS	15	22x1.5	1/2
			HD-WE-18L-BT-08	HD-WE-18L-BT-08-SS	18	26x1.5	1/2
		160	HD-WE-22L-BT-12	HD-WE-22L-BT-12-SS	22	30x2	3/4
			HD-WE-28L-BT-16	HD-WE-28L-BT-16-SS	28	36x2	1
			HD-WE-35L-BT-20	HD-WE-35L-BT-20-SS	35	45x2	1.1/4
			HD-WE-42L-BT-24	HD-WE-42L-BT-24-SS	42	52x2	1.1/2
	S	630	HD-WE-06S-BT-04	HD-WE-06S-BT-04-SS	6	14x1.5	1/4
			HD-WE-08S-BT-04	HD-WE-08S-BT-04-SS	8	16x1.5	1/4
			HD-WE-10S-BT-06	HD-WE-10S-BT-06-SS	10	18x1.5	3/8
			HD-WE-12S-BT-06	HD-WE-12S-BT-06-SS	12	20x1.5	3/8
			HD-WE-14S-BT-08	HD-WE-14S-BT-08-SS	14	22x1.5	1/2
		400	HD-WE-16S-BT-08	HD-WE-16S-BT-08-SS	16	24x1.5	1/2
			HD-WE-20S-BT-12	HD-WE-20S-BT-12-SS	20	30x2	3/4
			HD-WE-25S-BT-16	HD-WE-25S-BT-16-SS	25	36x2	1
			HD-WE-30S-BT-20	HD-WE-30S-BT-20-SS	30	42x2	1.1/4
			315	HD-WE-38S-BT-24	HD-WE-38S-BT-24-SS	38	52x2

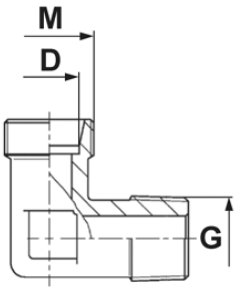
description	series	press. [bar]	code (galvanized steel)	code (AISI 316)	D [mm]	M [mm]	G [mm]
90° connector with metric tapered thread    <b>WE - MT</b>	L	315	HD-WE-06L-MT-10	HD-WE-06L-MT-10-SS	6	12x1.5	10x1
			HD-WE-08L-MT-12	HD-WE-08L-MT-12-SS	8	14x1.5	12x1.5
			HD-WE-10L-MT-14	HD-WE-10L-MT-14-SS	10	16x1.5	14x1.5
			HD-WE-12L-MT-16	HD-WE-12L-MT-16-SS	12	18x1.5	16x1.5
			HD-WE-15L-MT-18	HD-WE-15L-MT-18-SS	15	22x1.5	18x1.5
			HD-WE-18L-MT-22	HD-WE-18L-MT-22-SS	18	26x1.5	22x1.5
	S	630	HD-WE-06S-MT-12	HD-WE-06S-MT-12-SS	6	14x1.5	12x1.5
			HD-WE-08S-MT-14	HD-WE-08S-MT-14-SS	8	16x1.5	14x1.5
			HD-WE-10S-MT-16	HD-WE-10S-MT-16-SS	10	18x1.5	16x1.5
			HD-WE-12S-MT-18	HD-WE-12S-MT-18-SS	12	20x1.5	18x1.5
			HD-WE-14S-MT-20	HD-WE-14S-MT-20-SS	14	22x1.5	20x1.5
		400	HD-WE-16S-MT-22	HD-WE-16S-MT-22-SS	16	24x1.5	22x1.5

# HIGH PRESSURE - DIN 2353 connectors

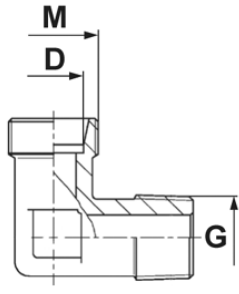
description	series	press. [bar]	code (galvanized steel)	code (AISI 316)	D [mm]	M [mm]	G [NPT]		
90° connector with NPT tapered thread    <b>WE - NT</b>	L	315	HD-WE-06L-NT-02	HD-WE-06L-NT-02-SS	6	12x1.5	1/8		
			HD-WE-08L-NT-04	HD-WE-08L-NT-04-SS	8	14x1.5	1/4		
			HD-WE-10L-NT-04	HD-WE-10L-NT-04-SS	10	16x1.5	1/4		
			HD-WE-12L-NT-06	HD-WE-12L-NT-06-SS	12	18x1.5	3/8		
			HD-WE-15L-NT-08	HD-WE-15L-NT-08-SS	15	22x1.5	1/2		
			HD-WE-18L-NT-08	HD-WE-18L-NT-08-SS	18	26x1.5	1/2		
		160	HD-WE-22L-NT-12	HD-WE-22L-NT-12-SS	22	30x2	3/4		
			HD-WE-28L-NT-16	HD-WE-28L-NT-16-SS	28	36x2	1		
			HD-WE-35L-NT-20	HD-WE-35L-NT-20-SS	35	45x2	1.1/4		
			HD-WE-42L-NT-24	HD-WE-42L-NT-24-SS	42	52x2	1.1/2		
			S	630	HD-WE-06S-NT-04	HD-WE-06S-NT-04-SS	6	14x1.5	1/4
					HD-WE-08S-NT-04	HD-WE-08S-NT-04-SS	8	16x1.5	1/4
	HD-WE-10S-NT-06	HD-WE-10S-NT-06-SS			10	18x1.5	3/8		
	HD-WE-12S-NT-06	HD-WE-12S-NT-06-SS			12	20x1.5	3/8		
	400	HD-WE-14S-NT-08		HD-WE-14S-NT-08-SS	14	22x1.5	1/2		
		HD-WE-16S-NT-08		HD-WE-16S-NT-08-SS	16	24x1.5	1/2		
		HD-WE-20S-NT-12	HD-WE-20S-NT-12-SS	20	30x2	3/4			
		HD-WE-25S-NT-16	HD-WE-25S-NT-16-SS	25	36x2	1			
	315	HD-WE-30S-NT-20	HD-WE-30S-NT-20-SS	30	42x2	1.1/4			
		HD-WE-38S-NT-24	HD-WE-38S-NT-24-SS	38	52x2	1.1/2			

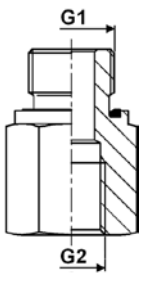
description	press. [bar]	code (galvanized steel)	code (AISI 316)	G1 [BSP]	G2 [BSP]	
BSP male connector with BSP female thread, DIN 3852-E seal    <b>RI - BE</b>	630	HD-RI-02-04-BE	HD-RI-02-04-BE-SS	1/8	1/4	
		HD-RI-04-02-BE	HD-RI-04-02-BE-SS	1/4	1/8	
		HD-RI-04-06-BE	HD-RI-04-06-BE-SS	1/4	3/8	
		HD-RI-04-08-BE	HD-RI-04-08-BE-SS	1/4	1/2	
		HD-RI-06-02-BE	HD-RI-06-02-BE-SS	3/8	1/8	
		HD-RI-06-04-BE	HD-RI-06-04-BE-SS	3/8	1/4	
		HD-RI-06-08-BE	HD-RI-06-08-BE-SS	3/8	1/2	
		HD-RI-08-04-BE	HD-RI-08-04-BE-SS	1/2	1/4	
		HD-RI-08-06-BE	HD-RI-08-06-BE-SS	1/2	3/8	
		400	HD-RI-08-12-BE	HD-RI-08-12-BE-SS	1/2	3/4
			HD-RI-12-06-BE	HD-RI-12-06-BE-SS	3/4	3/8
			HD-RI-12-08-BE	HD-RI-12-08-BE-SS	3/4	1/2
	HD-RI-12-16-BE		HD-RI-12-16-BE-SS	3/4	1	
	HD-RI-16-04-BE		HD-RI-16-04-BE-SS	1	1/4	
	HD-RI-16-06-BE		HD-RI-16-06-BE-SS	1	3/8	
	HD-RI-16-08-BE		HD-RI-16-08-BE-SS	1	1/2	
	HD-RI-16-12-BE		HD-RI-16-12-BE-SS	1	3/4	
	HD-RI-20-12-BE		HD-RI-20-12-BE-SS	1.1/4	3/4	
	HD-RI-20-16-BE		HD-RI-20-16-BE-SS	1.1/4	1	
	315		HD-RI-24-16-BE	HD-RI-24-16-BE-SS	1.1/2	1

# HIGH PRESSURE - DIN 2353 connectors

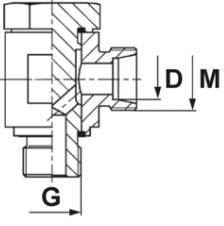
description	series	press. [bar]	code (galvanized steel)	code (AISI 316)	D [mm]	M [mm]	G [BSP]		
BANJO connector with BSP thread, DIN 3852-E seal    <b>WH - BE</b>	L	315	HD-WH-06L-BE-02	HD-WH-06L-BE-02-SS	6	12x1.5	1/8		
			HD-WH-08L-BE-04	HD-WH-08L-BE-04-SS	8	14x1.5	1/4		
			HD-WH-10L-BE-04	HD-WH-10L-BE-04-SS	10	16x1.5	1/4		
			HD-WH-12L-BE-06	HD-WH-12L-BE-06-SS	12	18x1.5	3/8		
			HD-WH-15L-BE-08	HD-WH-15L-BE-08-SS	15	22x1.5	1/2		
			HD-WH-18L-BE-08	HD-WH-18L-BE-08-SS	18	26x1.5	1/2		
		160	HD-WH-22L-BE-12	HD-WH-22L-BE-12-SS	22	30x2	3/4		
			HD-WH-28L-BE-16	HD-WH-28L-BE-16-SS	28	36x2	1		
			HD-WH-35L-BE-20	HD-WH-35L-BE-20-SS	35	45x2	1.1/4		
			HD-WH-42L-BE-24	HD-WH-42L-BE-24-SS	42	52x2	1.1/2		
			S	630	HD-WH-06S-BE-04	HD-WH-06S-BE-04-SS	6	14x1.5	1/4
					HD-WH-08S-BE-04	HD-WH-08S-BE-04-SS	8	16x1.5	1/4
	HD-WH-10S-BE-06	HD-WH-10S-BE-06-SS			10	18x1.5	3/8		
	400	HD-WH-12S-BE-06		HD-WH-12S-BE-06-SS	12	20x1.5	3/8		
		HD-WH-14S-BE-08		HD-WH-14S-BE-08-SS	14	22x1.5	1/2		
		HD-WH-16S-BE-08		HD-WH-16S-BE-08-SS	16	24x1.5	1/2		
	315	HD-WH-20S-BE-12	HD-WH-20S-BE-12-SS	20	30x2	3/4			
		HD-WH-25S-BE-16	HD-WH-25S-BE-16-SS	25	36x2	1			
		HD-WH-30S-BE-20	HD-WH-30S-BE-20-SS	30	42x2	1.1/4			
		HD-WH-38S-BE-24	HD-WH-38S-BE-24-SS	38	52x2	1.1/2			

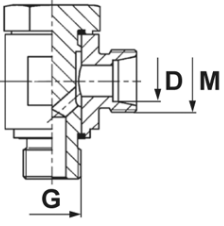
description	series	press. [bar]	code (galvanized steel)	code (AISI 316)	D [mm]	M [mm]	G [mm]		
BANJO connector with metric thread, DIN 3852-E seal    <b>WH - ME</b>	L	315	HD-WH-06L-ME-10	HD-WH-06L-ME-10-SS	6	12x1.5	10x1		
			HD-WH-08L-ME-12	HD-WH-08L-ME-12-SS	8	14x1.5	12x1.5		
			HD-WH-10L-ME-14	HD-WH-10L-ME-14-SS	10	16x1.5	14x1.5		
			HD-WH-12L-ME-16	HD-WH-12L-ME-16-SS	12	18x1.5	16x1.5		
			HD-WH-15L-ME-18	HD-WH-15L-ME-18-SS	15	22x1.5	18x1.5		
			HD-WH-18L-ME-22	HD-WH-18L-ME-22-SS	18	26x1.5	22x1.5		
		160	HD-WH-22L-ME-26	HD-WH-22L-ME-26-SS	22	30x2	26x1.5		
			HD-WH-28L-ME-33	HD-WH-28L-ME-33-SS	28	36x2	33x2		
			HD-WH-35L-ME-42	HD-WH-35L-ME-42-SS	35	45x2	42x2		
			HD-WH-42L-ME-48	HD-WH-42L-ME-48-SS	42	52x2	48x2		
			S	630	HD-WH-06S-ME-12	HD-WH-06S-ME-12-SS	6	14x1.5	12x1.5
					HD-WH-08S-ME-14	HD-WH-08S-ME-14-SS	8	16x1.5	14x1.5
	HD-WH-10S-ME-16	HD-WH-10S-ME-16-SS			10	18x1.5	16x1.5		
	400	HD-WH-12S-ME-18		HD-WH-12S-ME-18-SS	12	20x1.5	18x1.5		
		HD-WH-14S-ME-20		HD-WH-14S-ME-20-SS	14	22x1.5	20x1.5		
		HD-WH-16S-ME-22		HD-WH-16S-ME-22-SS	16	24x1.5	22x1.5		
	315	HD-WH-20S-ME-27	HD-WH-20S-ME-27-SS	20	30x2	27x2			
		HD-WH-25S-ME-33	HD-WH-25S-ME-33-SS	25	36x2	33x2			
		HD-WH-30S-ME-42	HD-WH-30S-ME-42-SS	30	42x2	42x2			
		HD-WH-38S-ME-48	HD-WH-38S-ME-48-SS	38	52x2	48x2			

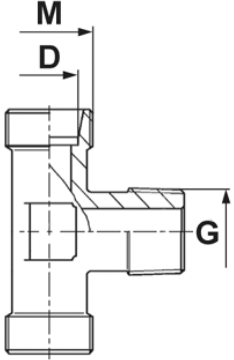

## HIGH PRESSURE - DIN 2353 connectors

description	series	press. [bar]	code (galvanized steel)	code (AISI 316)	D [mm]	M [mm]	G [BSPT]		
Connector with BSPT tapered thread    <b>TE - BT</b>	L	315	HD-TE-06L-BT-02	HD-TE-06L-BT-02-SS	6	12x1.5	1/8		
			HD-TE-08L-BT-04	HD-TE-08L-BT-04-SS	8	14x1.5	1/4		
			HD-TE-10L-BT-04	HD-TE-10L-BT-04-SS	10	16x1.5	1/4		
			HD-TE-12L-BT-06	HD-TE-12L-BT-06-SS	12	18x1.5	3/8		
			HD-TE-15L-BT-08	HD-TE-15L-BT-08-SS	15	22x1.5	1/2		
			HD-TE-18L-BT-08	HD-TE-18L-BT-08-SS	18	26x1.5	1/2		
		160	HD-TE-22L-BT-12	HD-TE-22L-BT-12-SS	22	30x2	3/4		
			HD-TE-28L-BT-16	HD-TE-28L-BT-16-SS	28	36x2	1		
			HD-TE-35L-BT-20	HD-TE-35L-BT-20-SS	35	45x2	1.1/4		
			HD-TE-42L-BT-24	HD-TE-42L-BT-24-SS	42	52x2	1.1/2		
			S	630	HD-TE-06S-BT-04	HD-TE-06S-BT-04-SS	6	14x1.5	1/4
					HD-TE-08S-BT-04	HD-TE-08S-BT-04-SS	8	16x1.5	1/4
	HD-TE-10S-BT-06	HD-TE-10S-BT-06-SS			10	18x1.5	3/8		
	HD-TE-12S-BT-06	HD-TE-12S-BT-06-SS			12	20x1.5	3/8		
	HD-TE-14S-BT-08	HD-TE-14S-BT-08-SS			14	22x1.5	1/2		
	400	HD-TE-16S-BT-08			HD-TE-16S-BT-08-SS	16	24x1.5	1/2	
		HD-TE-20S-BT-12	HD-TE-20S-BT-12-SS	20	30x2	3/4			
		HD-TE-25S-BT-16	HD-TE-25S-BT-16-SS	25	36x2	1			
		HD-TE-30S-BT-20	HD-TE-30S-BT-20-SS	30	42x2	1.1/4			
		315	HD-TE-38S-BT-24	HD-TE-38S-BT-24-SS	38	52x2	1.1/2		

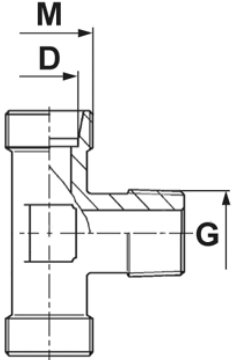
description	series	press. [bar]	code (galvanized steel)	code (AISI 316)	D [mm]	M [mm]	G [NPT]		
Connector with NPT tapered thread    <b>TE - NT</b>	L	315	HD-TE-06L-NT-02	HD-TE-06L-NT-02-SS	6	12x1.5	1/8		
			HD-TE-08L-NT-04	HD-TE-08L-NT-04-SS	8	14x1.5	1/4		
			HD-TE-10L-NT-04	HD-TE-10L-NT-04-SS	10	16x1.5	1/4		
			HD-TE-12L-NT-06	HD-TE-12L-NT-06-SS	12	18x1.5	3/8		
			HD-TE-15L-NT-08	HD-TE-15L-NT-08-SS	15	22x1.5	1/2		
			HD-TE-18L-NT-08	HD-TE-18L-NT-08-SS	18	26x1.5	1/2		
		160	HD-TE-22L-NT-12	HD-TE-22L-NT-12-SS	22	30x2	3/4		
			HD-TE-28L-NT-16	HD-TE-28L-NT-16-SS	28	36x2	1		
			HD-TE-35L-NT-20	HD-TE-35L-NT-20-SS	35	45x2	1.1/4		
			HD-TE-42L-NT-24	HD-TE-42L-NT-24-SS	42	52x2	1.1/2		
			S	630	HD-TE-06S-NT-04	HD-TE-06S-NT-04-SS	6	14x1.5	1/4
					HD-TE-08S-NT-04	HD-TE-08S-NT-04-SS	8	16x1.5	1/4
	HD-TE-10S-NT-06	HD-TE-10S-NT-06-SS			10	18x1.5	3/8		
	HD-TE-12S-NT-06	HD-TE-12S-NT-06-SS			12	20x1.5	3/8		
	HD-TE-14S-NT-08	HD-TE-14S-NT-08-SS			14	22x1.5	1/2		
	400	HD-TE-16S-NT-08			HD-TE-16S-NT-08-SS	16	24x1.5	1/2	
		HD-TE-20S-NT-12	HD-TE-20S-NT-12-SS	20	30x2	3/4			
		HD-TE-25S-NT-16	HD-TE-25S-NT-16-SS	25	36x2	1			
		HD-TE-30S-NT-20	HD-TE-30S-NT-20-SS	30	42x2	1.1/4			
		315	HD-TE-38S-NT-24	HD-TE-38S-NT-24-SS	38	52x2	1.1/2		

# HIGH PRESSURE - DIN 2353 connectors

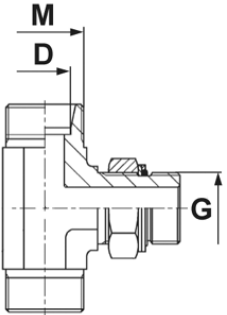
description	series	press. [bar]	code (galvanized steel)	code (AISI 316)	D [mm]	M [mm]	G [BSP]
Adjustable connector with BSP thread, ISO 1179-G seal    <b>TE - BG</b>	L	315	HD-TE-06L-BG-02	-	6	12x1.5	1/8
			HD-TE-08L-BG-04	-	8	14x1.5	1/4
			HD-TE-10L-BG-04	-	10	16x1.5	1/4
		250	HD-TE-12L-BG-06	-	12	18x1.5	3/8
			HD-TE-15L-BG-08	-	15	22x1.5	1/2
			HD-TE-18L-BG-08	-	18	26x1.5	1/2
			HD-TE-22L-BG-12	-	22	30x2	3/4
		160	HD-TE-28L-BG-16	-	28	36x2	1
			HD-TE-35L-BG-20	-	35	45x2	1.1/4
			HD-TE-42L-BG-24	-	42	52x2	1.1/2
	S	315	HD-TE-06S-BG-04	-	6	14x1.5	1/4
			HD-TE-08S-BG-04	-	8	16x1.5	1/4
		250	HD-TE-10S-BG-06	-	10	18x1.5	3/8
			HD-TE-12S-BG-06	-	12	20x1.5	3/8
			HD-TE-14S-BG-08	-	14	22x1.5	1/2
			HD-TE-16S-BG-08	-	16	24x1.5	1/2
		200	HD-TE-20S-BG-12	-	20	30x2	3/4
			HD-TE-25S-BG-16	-	25	36x2	1
		160	HD-TE-30S-BG-20	-	30	42x2	1.1/4
			HD-TE-38S-BG-24	-	38	52x2	1.1/2

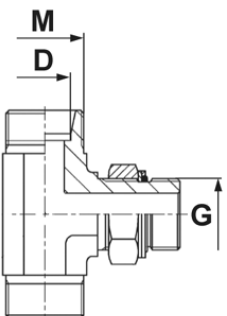
description	series	press. [bar]	code (galvanized steel)	code (AISI 316)	D [mm]	M [mm]	G [mm]
Adjustable connector with metric thread, ISO 6149-G seal    <b>TE - MG</b>	L	315	HD-TE-06L-MG-10	-	6	12x1.5	10x1
			HD-TE-08L-MG-12	-	8	14x1.5	12x1.5
			HD-TE-10L-MG-14	-	10	16x1.5	14x1.5
			HD-TE-12L-MG-16	-	12	18x1.5	16x1.5
			HD-TE-15L-MG-18	-	15	22x1.5	18x1.5
		250	HD-TE-18L-MG-22	-	18	26x1.5	22x1.5
			HD-TE-22L-MG-26	-	22	30x2	26x1.5
			HD-TE-28L-MG-33	-	28	36x2	33x2
			HD-TE-35L-MG-42	-	35	45x2	42x2
			HD-TE-42L-MG-48	-	42	52x2	48x2
	S	315	HD-TE-06S-MG-12	-	6	14x1.5	12x1.5
			HD-TE-08S-MG-14	-	8	16x1.5	14x1.5
			HD-TE-10S-MG-16	-	10	18x1.5	16x1.5
		250	HD-TE-12S-MG-18	-	12	20x1.5	18x1.5
			HD-TE-14S-MG-20	-	14	22x1.5	20x1.5
			HD-TE-16S-MG-22	-	16	24x1.5	22x1.5
			HD-TE-20S-MG-27	-	20	30x2	27x2
		160	HD-TE-25S-MG-33	-	25	36x2	33x2
			HD-TE-30S-MG-42	-	30	42x2	42x2
			HD-TE-38S-MG-48	-	38	52x2	48x2

## HIGH PRESSURE - DIN 2353 connectors

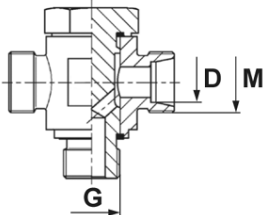
description	series	press. [bar]	code (galvanized steel)	code (AISI 316)	D [mm]	M [mm]	G [BSP]		
BANJO connector with BSP thread, DIN 3852-E seal    <b>TH - BE</b>	L	315	HD-TH-06L-BE-02	HD-TH-06L-BE-02-SS	6	12x1.5	1/8		
			HD-TH-08L-BE-04	HD-TH-08L-BE-04-SS	8	14x1.5	1/4		
			HD-TH-10L-BE-04	HD-TH-10L-BE-04-SS	10	16x1.5	1/4		
			HD-TH-12L-BE-06	HD-TH-12L-BE-06-SS	12	18x1.5	3/8		
			HD-TH-15L-BE-08	HD-TH-15L-BE-08-SS	15	22x1.5	1/2		
			HD-TH-18L-BE-08	HD-TH-18L-BE-08-SS	18	26x1.5	1/2		
		160	HD-TH-22L-BE-12	HD-TH-22L-BE-12-SS	22	30x2	3/4		
			HD-TH-28L-BE-16	HD-TH-28L-BE-16-SS	28	36x2	1		
			HD-TH-35L-BE-20	HD-TH-35L-BE-20-SS	35	45x2	1.1/4		
			HD-TH-42L-BE-24	HD-TH-42L-BE-24-SS	42	52x2	1.1/2		
			S	630	HD-TH-06S-BE-04	HD-TH-06S-BE-04-SS	6	14x1.5	1/4
					HD-TH-08S-BE-04	HD-TH-08S-BE-04-SS	8	16x1.5	1/4
	HD-TH-10S-BE-06	HD-TH-10S-BE-06-SS			10	18x1.5	3/8		
	HD-TH-12S-BE-06	HD-TH-12S-BE-06-SS			12	20x1.5	3/8		
	HD-TH-14S-BE-08	HD-TH-14S-BE-08-SS			14	22x1.5	1/2		
	400	HD-TH-16S-BE-08			HD-TH-16S-BE-08-SS	16	24x1.5	1/2	
		HD-TH-20S-BE-12	HD-TH-20S-BE-12-SS	20	30x2	3/4			
		HD-TH-25S-BE-16	HD-TH-25S-BE-16-SS	25	36x2	1			
		HD-TH-30S-BE-20	HD-TH-30S-BE-20-SS	30	42x2	1.1/4			
	315	HD-TH-38S-BE-24	HD-TH-38S-BE-24-SS	38	52x2	1.1/2			

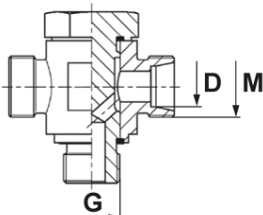
description	series	press. [bar]	code (galvanized steel)	code (AISI 316)	D [mm]	M [mm]	G [mm]		
BANJO connector with metric thread, DIN 3852-E seal    <b>TH - ME</b>	L	315	HD-TH-06L-ME-10	HD-TH-06L-ME-10-SS	6	12x1.5	10x1		
			HD-TH-08L-ME-12	HD-TH-08L-ME-12-SS	8	14x1.5	12x1.5		
			HD-TH-10L-ME-14	HD-TH-10L-ME-14-SS	10	16x1.5	14x1.5		
			HD-TH-12L-ME-16	HD-TH-12L-ME-16-SS	12	18x1.5	16x1.5		
			HD-TH-15L-ME-18	HD-TH-15L-ME-18-SS	15	22x1.5	18x1.5		
			HD-TH-18L-ME-22	HD-TH-18L-ME-22-SS	18	26x1.5	22x1.5		
		160	HD-TH-22L-ME-26	HD-TH-22L-ME-26-SS	22	30x2	26x1.5		
			HD-TH-28L-ME-33	HD-TH-28L-ME-33-SS	28	36x2	33x2		
			HD-TH-35L-ME-42	HD-TH-35L-ME-42-SS	35	45x2	42x2		
			HD-TH-42L-ME-48	HD-TH-42L-ME-48-SS	42	52x2	48x2		
			S	630	HD-TH-06S-ME-12	HD-TH-06S-ME-12-SS	6	14x1.5	12x1.5
					HD-TH-08S-ME-14	HD-TH-08S-ME-14-SS	8	16x1.5	14x1.5
	HD-TH-10S-ME-16	HD-TH-10S-ME-16-SS			10	18x1.5	16x1.5		
	HD-TH-12S-ME-18	HD-TH-12S-ME-18-SS			12	20x1.5	18x1.5		
	HD-TH-14S-ME-20	HD-TH-14S-ME-20-SS			14	22x1.5	20x1.5		
	400	HD-TH-16S-ME-22			HD-TH-16S-ME-22-SS	16	24x1.5	22x1.5	
		HD-TH-20S-ME-27	HD-TH-20S-ME-27-SS	20	30x2	27x2			
		HD-TH-25S-ME-33	HD-TH-25S-ME-33-SS	25	36x2	33x2			
		HD-TH-30S-ME-42	HD-TH-30S-ME-42-SS	30	42x2	42x2			
	315	HD-TH-38S-ME-48	HD-TH-38S-ME-48-SS	38	52x2	48x2			

# HIGH PRESSURE - DIN 2353 connectors

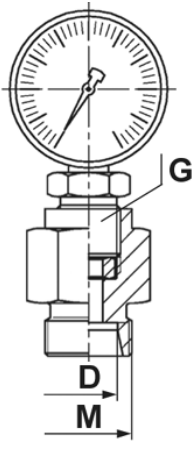
description	series	press. [bar]	code (galvanized steel)	code (AISI 316)	D [mm]	M [mm]	G [BSP]
Pressure gauge connector with BSP thread   <b>MAV - B</b>	L	315	HD-MAV-06L-B-04	HD-MAV-06L-B-04-SS	6	12x1.5	1/4
			HD-MAV-08L-B-04	HD-MAV-08L-B-04-SS	8	14x1.5	1/4
			HD-MAV-10L-B-04	HD-MAV-10L-B-04-SS	10	16x1.5	1/4
			HD-MAV-12L-B-04	HD-MAV-12L-B-04-SS	12	18x1.5	1/4
	S	630	HD-MAV-06S-B-08	HD-MAV-06S-B-08-SS	6	14x1.5	1/2
			HD-MAV-08S-B-08	HD-MAV-08S-B-08-SS	8	16x1.5	1/2
			HD-MAV-10S-B-08	HD-MAV-10S-B-08-SS	10	18x1.5	1/2
			HD-MAV-12S-B-08	HD-MAV-12S-B-08-SS	12	20x1.5	1/2

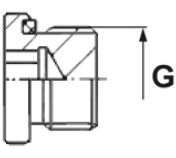
description	press. [bar]	code (galvanized steel)	code (AISI 316)	G [BSP]
Dust cap with BSP thread, DIN 3852-E seal   <b>VSTI - BE</b>	400	HD-VSTI-02-BE	HD-VSTI-02-BE-SS	1/8
		HD-VSTI-04-BE	HD-VSTI-04-BE-SS	1/4
		HD-VSTI-06-BE	HD-VSTI-06-BE-SS	3/8
		HD-VSTI-08-BE	HD-VSTI-08-BE-SS	1/2
		HD-VSTI-12-BE	HD-VSTI-12-BE-SS	3/4
		HD-VSTI-16-BE	HD-VSTI-16-BE-SS	1
	250	HD-VSTI-20-BE	HD-VSTI-20-BE-SS	1.1/4
		HD-VSTI-24-BE	HD-VSTI-24-BE-SS	1.1/2

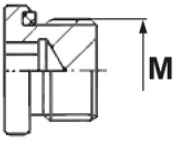
description	press. [bar]	code (galvanized steel)	code (AISI 316)	G [mm]
Dust cap with metric thread, DIN 3852-E seal   <b>VSTI - ME</b>	400	HD-VSTI-10-ME	HD-VSTI-10-ME-SS	10x1
		HD-VSTI-12-ME	HD-VSTI-12-ME-SS	12x1.5
		HD-VSTI-14-ME	HD-VSTI-14-ME-SS	14x1.5
		HD-VSTI-16-ME	HD-VSTI-16-ME-SS	16x1.5
		HD-VSTI-18-ME	HD-VSTI-18-ME-SS	18x1.5
		HD-VSTI-20-ME	HD-VSTI-20-ME-SS	20x1.5
		HD-VSTI-22-ME	HD-VSTI-22-ME-SS	22x1.5
		HD-VSTI-26-ME	HD-VSTI-26-ME-SS	26x1.5
		HD-VSTI-27-ME	HD-VSTI-27-ME-SS	27x2
		HD-VSTI-33-ME	HD-VSTI-33-ME-SS	33x2
	250	HD-VSTI-42-ME	HD-VSTI-42-ME-SS	42x2
		HD-VSTI-48-ME	HD-VSTI-48-ME-SS	48x2

## HIGH PRESSURE - DIN 2353 connectors

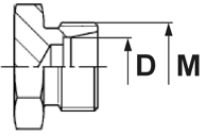
description	series	press. [bar]	code (galvanized steel)	code (AISI 316)	D [mm]	M [mm]
Dust cap    <b>ROV</b>	L	315	HD-ROV-06L	HD-ROV-06L-SS	6	12x1.5
			HD-ROV-08L	HD-ROV-08L-SS	8	14x1.5
			HD-ROV-10L	HD-ROV-10L-SS	10	16x1.5
			HD-ROV-12L	HD-ROV-12L-SS	12	18x1.5
			HD-ROV-15L	HD-ROV-15L-SS	15	22x1.5
			HD-ROV-18L	HD-ROV-18L-SS	18	26x1.5
		160	HD-ROV-22L	HD-ROV-22L-SS	22	30x2
			HD-ROV-28L	HD-ROV-28L-SS	28	36x2
			HD-ROV-35L	HD-ROV-35L-SS	35	45x2
			HD-ROV-42L	HD-ROV-42L-SS	42	52x2
	S	630	HD-ROV-06S	HD-ROV-06S-SS	6	14x1.5
			HD-ROV-08S	HD-ROV-08S-SS	8	16x1.5
			HD-ROV-10S	HD-ROV-10S-SS	10	18x1.5
			HD-ROV-12S	HD-ROV-12S-SS	12	20x1.5
			HD-ROV-14S	HD-ROV-14S-SS	14	22x1.5
		400	HD-ROV-16S	HD-ROV-16S-SS	16	24x1.5
			HD-ROV-20S	HD-ROV-20S-SS	20	30x2
			HD-ROV-25S	HD-ROV-25S-SS	25	36x2
			HD-ROV-30S	HD-ROV-30S-SS	30	42x2
			HD-ROV-38S	HD-ROV-38S-SS	38	52x2

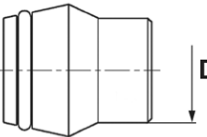
description	series	press. [bar]	code (galvanized steel)	code (AISI 316)	D [mm]
Plug    <b>VKA</b>	L/S	630	HD-VKA-06L-S	HD-VKA-06L-S-SS	6
			HD-VKA-08L-S	HD-VKA-08L-S-SS	8
			HD-VKA-10L-S	HD-VKA-10L-S-SS	10
			HD-VKA-12L-S	HD-VKA-12L-S-SS	12
	L	315	HD-VKA-15L	HD-VKA-15L-SS	15
			HD-VKA-18L	HD-VKA-18L-SS	18
		160	HD-VKA-22L	HD-VKA-22L-SS	22
			HD-VKA-28L	HD-VKA-28L-SS	28
			HD-VKA-35L	HD-VKA-35L-SS	35
			HD-VKA-42L	HD-VKA-42L-SS	42
	S	630	HD-VKA-14S	HD-VKA-14S-SS	14
			HD-VKA-16S	HD-VKA-16S-SS	16
		400	HD-VKA-20S	HD-VKA-20S-SS	20
			HD-VKA-25S	HD-VKA-25S-SS	25
			HD-VKA-30S	HD-VKA-30S-SS	30
			HD-VKA-38S	HD-VKA-38S-SS	38